

COMSOL NEWS

SPECIAL EDITION **ACOUSTICS**



Computational Acoustics Provides Early Insight and Predictive Ability in the Design Process

When we discuss acoustics, the first images that might come to mind are of a loud subwoofer or a concert hall with all of its sound baffles. But there are many more acoustics applications that we come into contact with everyday. Acoustics is a multidisciplinary science requiring engineers to resort to all of their ingenuity and the most powerful mathematical modeling tools to create products that satisfy many customers' requirements.

This special edition of *COMSOL News* celebrates designers, engineers, and researchers working in the field of acoustics. As you will see by reading their stories, the common denominator is a passion for high-fidelity multiphysics modeling, flexibility, and the ability to share their work with colleagues and customers through simulation apps.

From virtual product development to NVH performance, acoustic cloaking, and feedback reduction, I'm sure you will feel inspired from reading about the many ways computational acoustics drives the solution of practical problems and the design of innovative products.

Enjoy your reading!



Valerio Marra
Marketing Director
COMSOL, Inc.

INTERACT WITH THE COMSOL COMMUNITY



COMSOL, Inc.



COMSOL Multiphysics



@COMSOL_Inc



plus.google.com/+comsol

BLOG comsol.com/blogs

Forum comsol.com/community/forums

We welcome your comments on *COMSOL News*; contact us at info@comsol.com

COMSOL NEWS

Special Edition
Acoustics

© 2017 COMSOL. COMSOL, COMSOL Multiphysics, Capture the Concept, COMSOL Desktop, COMSOL Server, and LiveLink are either registered trademarks or trademarks of COMSOL AB. All other trademarks are the property of their respective owners, and COMSOL AB and its subsidiaries and products are not affiliated with, endorsed by, sponsored by, or supported by those trademark owners. For a list of such trademark owners, see www.comsol.com/trademarks.

The IN logo is a registered trademark or trademark of LinkedIn Corporation and its affiliates in the United States and/or other countries. The 'f' logo is a registered trademark of Facebook, Inc. The bird logo is a registered trademark of Twitter, Inc. The G+ logo is a trademark of Google, Inc.

CONTENTS



ACOUSTICS SIMULATION

- 4 | Making the Case for Acoustic Modeling and Simulation Apps

VIRTUAL PRODUCT DEVELOPMENT

- 6 | Virtually Tuning an Automotive Audio System

HIGH-PRECISION MICROPHONES

- 9 | Precision Performance: The Pursuit of Perfect Measurement

COMBUSTION INSTABILITY

- 12 | Multiphysics Software Models Mean Flow-Augmented Acoustics in Rocket Systems

NVH PERFORMANCE

- 15 | Behind the Rumble and Roar of Mahindra Motorcycles

TRANSFORMER HUM

- 18 | From Spreadsheets to Multiphysics Applications, ABB Continues to Power up the Transformer Industry



ON THE COVER

Adventure-touring motorcycle Mahindra Mojo. Image credit: Mahindra Two Wheelers Ltd.

FEATURES

MULTIBODY-ACOUSTICS INTERACTION

22 | Modeling Vibration and Noise in a Gearbox

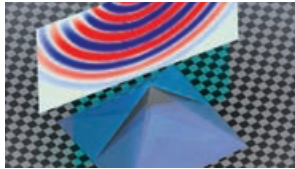

ACOUSTIC CLOAKING

25 | Manipulate and Control Sound: How Mathematical Modeling Supports Cutting-Edge Acoustic Metamaterials Research



36

INFRASOUND-INDUCED VIBRATIONS

28 | Shake, Rattle, and Roll

FEEDBACK REDUCTION

30 | On the Cutting Edge of Hearing Aid Research

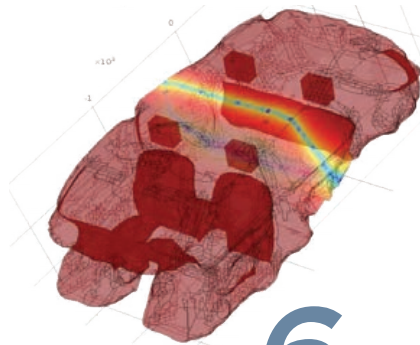

6

33

NONINVASIVE ACOUSTIC TECHNOLOGY

33 | Multiphysics Analysis Enhances Water Main Leak Detection

HIGH-PRECISION TRANSDUCERS

36 | Music to Your Ears: New Transducers Meet Electrostatic Headphones

MULTIPHYSICS MODELING

39 | Simulating the World Through the Lens of Multiphysics

GUEST EDITORIAL

40 | How Computational Acoustics Benefits from Multiphysics

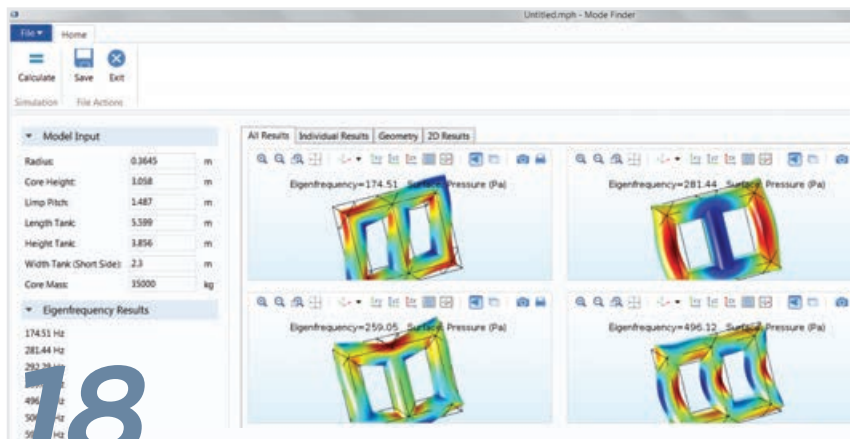

78

MAKING THE CASE FOR ACOUSTIC MODELING AND SIMULATION APPS

Acoustic phenomena are multiphysics in nature. When building a model, engineers must account for several types of physics and their coupling at different scales and frequencies.

by **MADS J. HERRING JENSEN**

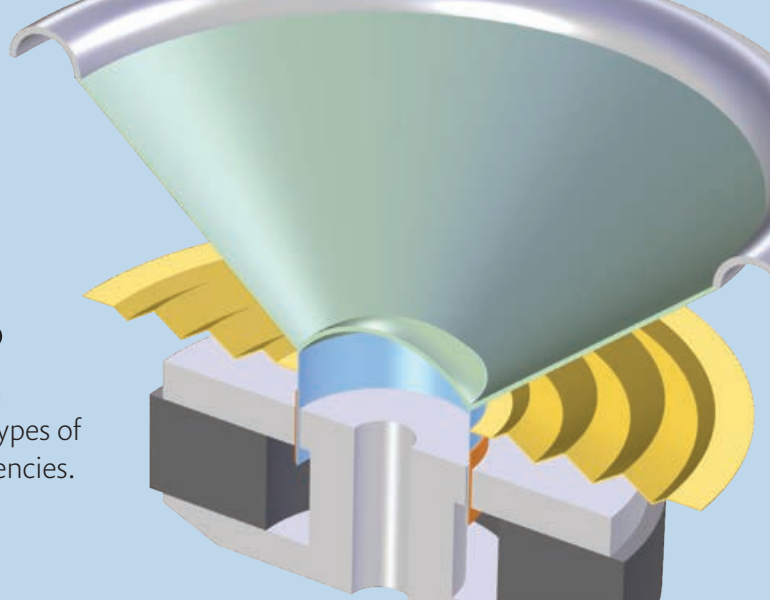

With increasingly complex systems and tighter project deadlines, acoustical engineers are turning to numerical simulation software to get the job done. By using computational tools, design tasks can be accelerated and the need for costly and time-consuming physical prototypes can be reduced. Acoustics simulation also increases the understanding of a design, leading to better informed decisions and higher-quality products.

To reap the benefits, what capabilities are important in acoustics simulation? Applications often include the reproduction, propagation, and reception of sound signals under diverse conditions. This includes not only the interaction of the sound signal with structures, porous materials, and flow, but also modeling the transducers involved in the generation and detection of the sound signals. All these are multiphysics problems by nature that acousticians have to consider for the efficient development of new products and technologies. This places a critical requirement on the modeling software in terms of the ability to couple physics effects relevant to the full system.

⇒ CURRENT TECHNOLOGICAL CHALLENGES IN ACOUSTICS

Sound quality is a trending topic in many industries. This concerns the reproduction of sound inside, for example, car cabins (Figure 1) or the output from the exhaust and muffler systems. Other examples include the performance and optimization of headphones and loudspeakers or the speaker system of mobile devices. In all of

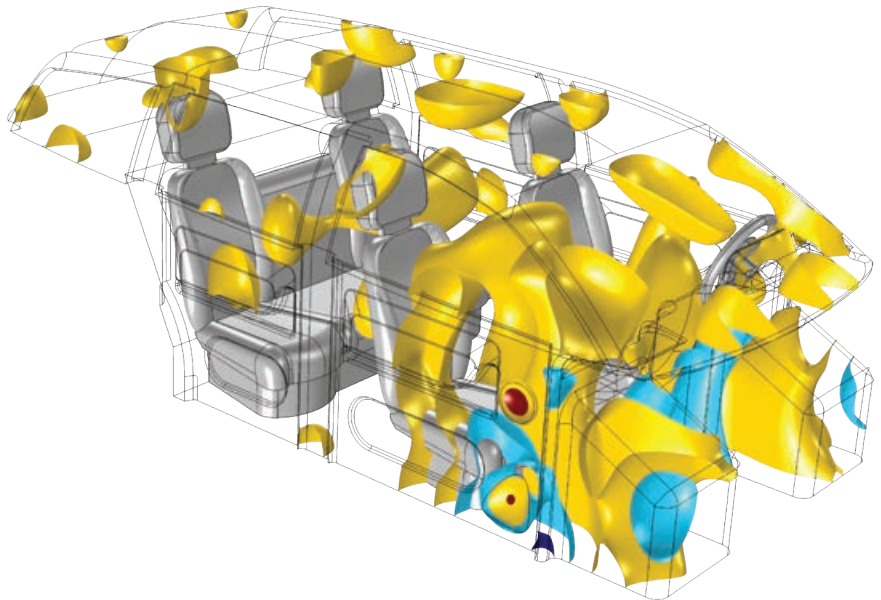

FIGURE 1. Acoustics simulation of a sedan interior including sound sources at the typical loudspeaker locations. Results show the total acoustic pressure field inside the cabin.

these cases, a detailed understanding of both sound propagation and transducer behavior is necessary to optimize the systems. Clever digital signal processing is not enough anymore to make systems behave and “sound good”. For example, to improve the performance of hearing aids using adaptive feedback canceling, a coupling of a miniature loudspeaker vibroacoustics model with an acoustic and solid mechanics finite element (FE) model is needed for producing accurate simulation results.

In the loudspeaker industry, a standard driver design has reached the limit of where improvements can be done by

simple trial-and-error testing (Figure 2). Optimization requires detailed numerical analysis. Miniature loudspeaker systems are now driven at such high sound pressure levels that distortion and attenuation due to nonlinearities are introduced. The same nonlinearities also play a significant role in liners in aerospace applications.

Another example involving a multiphysics coupling — electrostatics, structural membranes, and thermoviscous acoustics — is the modeling of condenser microphones. The physics are tightly coupled and all necessary for a correct prediction of the microphone sensitivity.

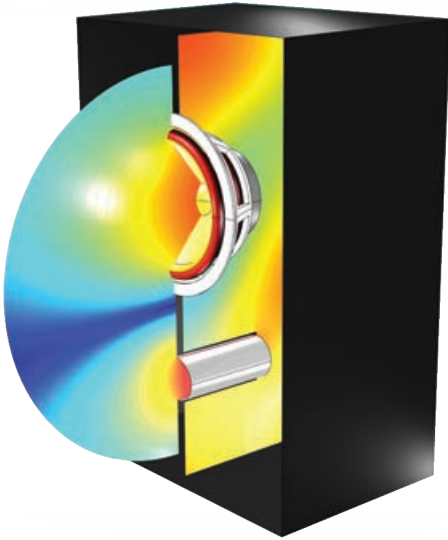

FIGURE 2. Simulation results showing the sound pressure distribution in a loudspeaker driver enclosure.

⇒ COMSOL MULTIPHYSICS AND THE ACOUSTICS MODULE

The Acoustics Module, an add-on product to the COMSOL Multiphysics® software, is ideally suited for modeling the many decades of frequencies involved in

acoustics, ranging from infrasound to ultrasound, as well as the multiscale nature of acoustics when dealing with, among others, thermoviscous loss mechanisms or aeroacoustics. The acoustic simulation capabilities of the software include built-in easy-to-use multiphysics couplings between the different physics, which are set up seamlessly in the same modeling environment, while the Acoustics Module adds many specialized formulations of the governing equations of acoustics.

⇒ ACOUSTICS SIMULATION APPS

To tackle the acoustic challenges faced by many in the industry, users without previous simulation software experience can run apps specifically tailored for them and their needs with predefined inputs and desired outputs. This is possible using apps created with the Application Builder available in COMSOL Multiphysics. Simulation apps are multiphysics models wrapped in a custom user interface. With this tool, specialists can package a complex simulation and allow users to change design parameters and analyze results autonomously with respect to industry standards and customer requirements.

Thanks to a local installation of the COMSOL Server™ product, apps can

be easily deployed to colleagues and customers throughout an organization and worldwide. Users can connect via the COMSOL Client or a major web browser. It has never been easier for simulation specialists to model acoustic devices with such high fidelity and let their colleagues benefit from their work. ❖

PHYSICS INTERFACES AVAILABLE IN THE ACOUSTICS MODULE

Pressure Acoustics: The sound field is described by acoustic variations around the ambient static pressure. Porous and fibrous materials, narrow structures, and bulk absorption behavior are modeled. Perfectly matched layers (PMLs) are available to truncate unbounded domains.

Acoustic-Structure Interaction: Models phenomena where the fluid's pressure causes a load on the solid domain and the structural acceleration affects the fluid domain across the fluid-solid boundary. Piezoelectric material, elastic and poroelastic waves, and pipe acoustics are included.

Aeroacoustics: Solves the one-way interaction of a background fluid flow with an acoustic field.

Thermoviscous Acoustics: Accurately models acoustics in geometries with small dimensions where the effect of the viscous and thermal boundary layer near the walls is important.

Ultrasound: Solves large transient linear acoustic problems containing many wavelengths in a stationary background flow field.

Geometrical Acoustics: Models acoustics in the high-frequency limit where the wavelength is significantly smaller than the characteristic geometrical features.

RESOURCES

- [COMSOL Blog](#)
- [COMSOL Video Gallery](#)
- [COMSOL Application Gallery](#)

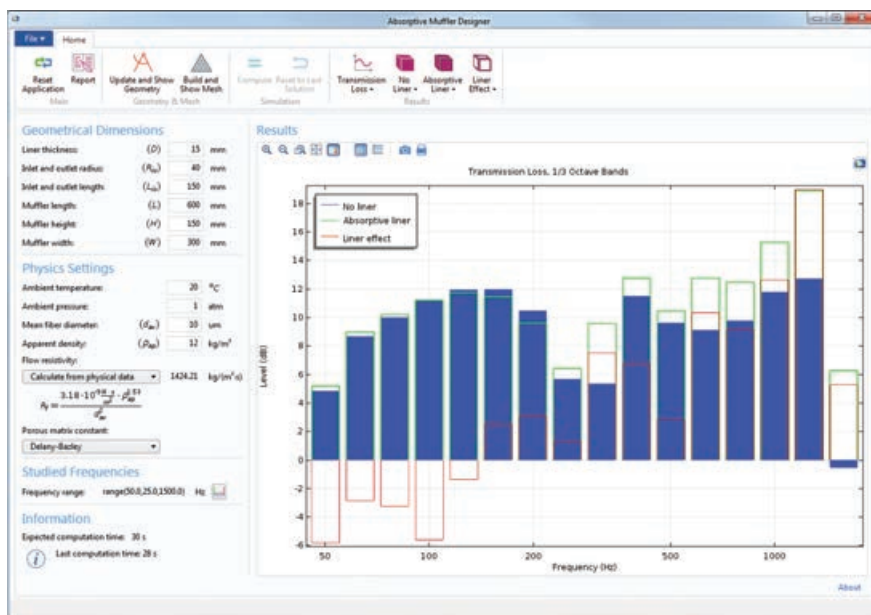

FIGURE 3. This example app is based on a model in COMSOL Multiphysics® of an absorptive muffler. The user may change the geometric design of the muffler, the ambient temperature and pressure, and material properties in order to evaluate the resulting acoustic behavior.

VIRTUALLY TUNING AN AUTOMOTIVE AUDIO SYSTEM

Experts at HARMAN are using physical experiments in conjunction with mathematical modeling and numerical simulation to improve the development process for the latest vehicle infotainment technology.

by **JENNIFER HAND**



FIGURE 1. Loudspeaker positioning in the vehicle interior.

Today's vehicles offer dazzling electronic entertainment possibilities, from smartphone connectivity to interactive displays and video screens. HARMAN is the market leader in these connected car setups, equipping more than 80% of the world's luxury cars with premium audio systems.

Each vehicle model requires a unique configuration, and HARMAN's team of acoustic and simulation specialists ensure that different components and car acoustics are accounted for in their design process. Details such as the ideal placement and orientation of speakers, speaker packaging, and driver enclosure geometry such as car doors all influence the sound quality.

The team uses physical experiments in conjunction with numerical analysis to accelerate product development by virtually "tuning" their systems before ever creating a live prototype. This saves time on physical testing, and allows virtual tests to replace in situ listening, so that the team can design their products even before the final car designs are complete.

"We may become involved very early in the car development process, when a vehicle designer has not yet decided what is required from the audio system," explains Michael Strauss, Senior Manager of Virtual Product Development and Tools (VPD) at HARMAN. "Or we may only have basic details such as size and volume of the car cabin. Yet frequently we need to present a concept within a few days, creating a tricky

challenge to meet our clients' requirements and deliver high-quality systems."

⇒ SIMULATION AND EXPERIMENTS TEAM UP FOR CUSTOMER SATISFACTION

To provide customers with a response that is both quick and accurate, engineers at HARMAN turn to mathematical modeling in COMSOL Multiphysics® software. "We needed capabilities for mechanical, acoustic, and electrical simulations in one integrated environment, and we wanted

Michał Bogdanski, Simulation Engineer and Leader of the Project at HARMAN. "We can explore how the acoustic behavior of a loudspeaker relates to any part of a vehicle structure — for example the stiffness of a door — and then provide door design guidelines to our customer."

In one case, they both measured and simulated the sound pressure levels generated by a loudspeaker in the cabin of a Mercedes-Benz ML car (Figure 1) in order to validate their numerical models and later use them to optimize acoustic equipment. "Car cabin simulations are among the most challenging to run because they cover many different areas of physics," explains Strauss. Fortunately, COMSOL® software offers options to couple together the acoustic, mechanical, and electrical effects throughout the system.

To support companywide engineering efforts, Strauss' team established a library of validated models and known solutions that allows for performance predictions of a wide variety of loudspeaker configurations. "We are able

"We needed capabilities for mechanical, acoustic, and electrical simulations in one integrated environment, and we wanted a program that would free up the time and effort spent on creating and updating our own tools."

a program that would free up the time and effort spent on creating and updating our own tools," says François Malbos, Principal Acoustics Engineer, at HARMAN.

"The multiphysics approach is one of the most important parts of the virtual product development process," says

to offer everything from a high level trend analysis to a detailed design examining the performance of a subsystem," he continues.

⇒ ANALYZING VEHICLE LOUDSPEAKER

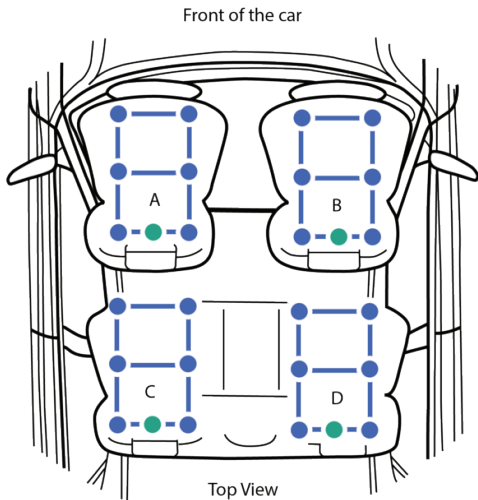

FIGURE 2. Left, top view of the microphone arrays positioned in the four different locations.



FIGURE 3. HARMAN's 3D scan of the car cabin.

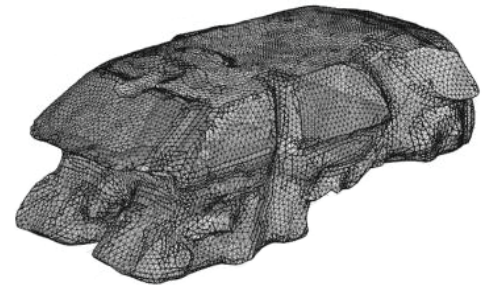

FIGURE 4. Surface mesh of the car cabin.

PERFORMANCE

In one study, engineers at HARMAN used COMSOL to create a simulation of a car cabin's sound system in order to optimize the speaker acoustics, specifically for low-frequency soundwaves. They then designed a series of tests to validate the model. Once validated, the model would allow the HARMAN team to deduce the best loudspeaker setup for a given car.

In validation tests, a loudspeaker was mounted on a rigid enclosure near the driver's seat of the car. Four sets of microphone arrays throughout the cabin served to measure the average sound pressure levels at each location (see Figure 2).

For frequencies below 1 kHz, the loudspeaker was represented as a rigid flat piston tied to a simplified lumped parameter model (LPM) taking into account the voltage at the voice coil terminals and the stiffness of the suspension and speaker membrane surface. The geometry was generated from a manual 3D scan (see Figure 3). Using a postprocessing

algorithm implemented in MATLAB® software and an add-on product to COMSOL® called LiveLink for MATLAB® that creates a bidirectional link between the two programs, the team converted the point cloud created by the scan into a surface mesh of the car cabin (see Figure 4) and created an optimized mesh for studying acoustic pressure waves.

The simulation analyzed the interaction of the sound waves generated by a speaker with the different materials of

the windshield, floor, seats, headrests, steering wheel, and other sections such as the roof, doors, and instrument panels, each of which have different absorption properties.

⇒ **OPTIMIZING THE ACOUSTIC MODEL**

In addition to accounting for many different materials, the team also defined speaker membrane motion and acceleration based on the volume of the enclosure using the LiveLink™ for MATLAB® and developed special MATLAB® scripts to simplify the preprocessing and postprocessing activities.

"Everything is fully optimized and automatic so that we do not have to calculate the acceleration for each case; when one simulation finishes, the next launches," explains Michal Bogdanski. "This ensures that the whole process is easy and error-free; we simply let the scripts run."

The team also optimized the frequency-dependent absorption coefficients necessary to achieve a strong

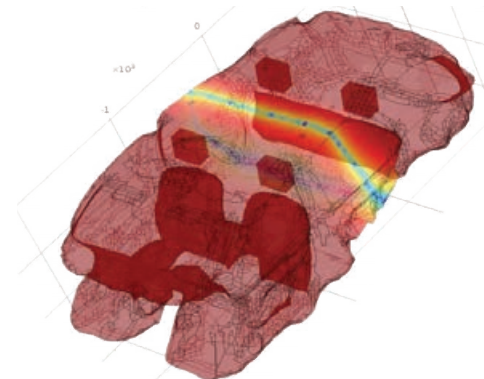
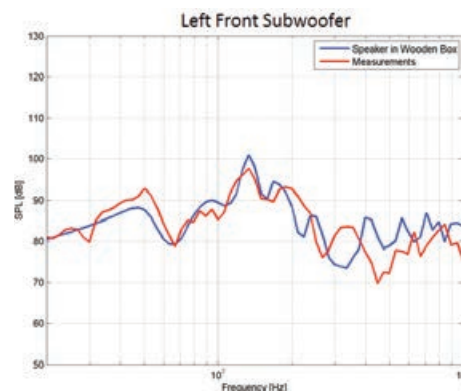

FIGURE 5. Sound pressure levels for one microphone array (left) and throughout the cabin (right).

correlation between the measured and simulated sound pressures. The analysis then provided the sound pressure levels emanating from each microphone array (see Figure 5).

⇒ **OBJECTIVE AND SUBJECTIVE EVALUATIONS IN THE DRIVER'S SEAT**

Using their validated simulations, HARMAN is able to begin developing a sound system even as a vehicle is still being designed. The accurate prediction of the sound pressure field throughout the car cabin allows for

“Using simulation Harman engineers will be able to assess, optimize, predict and subjectively evaluate the performance of a proposed sound system, even though it does not actually exist yet.”

optimization of audio system performance. Equalizers and psychoacoustic effects are also included in their tuning algorithm, allowing for design modifications without the need for a physical prototype.

Auralization, or the production of sound from virtually computed acoustics, is of interest in the pursuit of a top-notch sound system. Using a high end headphone, Engineers at HARMAN have developed a playback system that allows, for listening, evaluation, and comparison of audio systems comprising

subwoofers, midranges, and tweeters. “All based on simulation results and signal processing,” says Malbos.

HARMAN engineers include the effects of the human head, torso and ear canals on acoustics in predicting Binaural Impulse Responses (BRIR), or how ears receive a sound. To capture the full 3D sound, BRIR are computed at various head positions in the azimuth plane. The playback system uses a head position tracker to perfectly reproduce the sound experience as the listener would experience it, e.g. in the driver's seat.

Figure 6 depicts the mesh created using COMSOL® software that was used in predicting the BRIR. Figure 7 shows a comparison between predicted and simulated BRIR.

Auralization is not without its challenges. Auralization quality, a measure that is inherently subjective, must compare to real-world listening. As such, subjective measurements are made to ensure the quality of the listening experience.

At HARMAN, the ability to assess an audio system based purely on simulation has increased the quality of product and speed of product development. It also has improved customer responsiveness, and lowered the cost of design amendments, fostering a sense of design freedom among the engineers.

“The beauty of simulation is that a systems engineer can sit at a desk, put headphones on and begin to tune a system without the car,” Says Strauss. “Using simulation Harman engineers will be able to assess, optimize, predict and subjectively evaluate the performance of a proposed sound system, even though it does not actually exist yet.” ❖

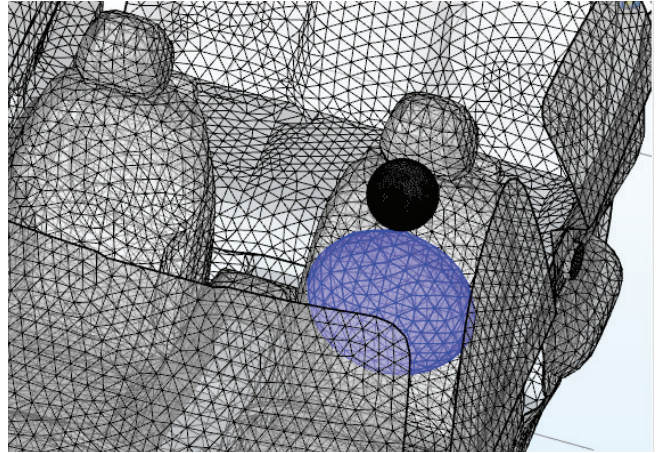

FIGURE 6. Mesh created using COMSOL® used for the prediction of binaural impulse responses, or how ears receive a sound.

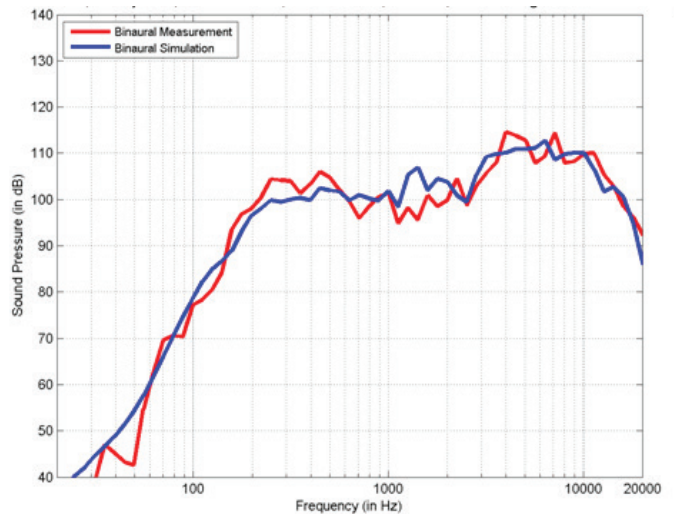

FIGURE 7. Comparison of measured and simulated BRIR in the frequency domain.



The HARMAN VPD team consists of Maruthi Srinivasarao Reddy, Michal Bogdanski, Michael Strauss, Ninranjan Ambati, and François Malbos.

Precision Performance: The Pursuit of Perfect Measurement

Researchers at Brüel & Kjær are using simulation to achieve new levels of precision and accuracy for their industrial and measurement-grade microphones and transducers.

by **VALERIO MARRA**

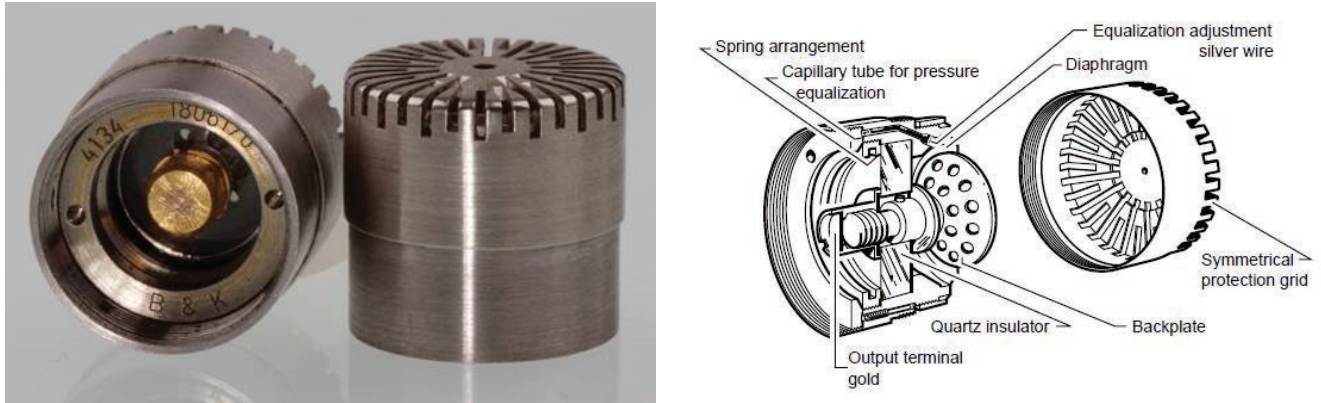

FIGURE 1. Left: Photo of a 4134 microphone including the protective grid mounted above the diaphragm. Right: Sectional view of a typical microphone cartridge showing its main components.

There will never be a perfect measurement taken or an infallible instrument created. While we may implicitly trust the measurements we take, no measurement will ever be flawless, as our instruments do not define what they measure. Instead, they react to surrounding phenomena and interpret this data against an imperfect representation of an absolute standard.

Therefore, all instruments have a degree of acceptable error—an allowable amount that measurements can differ without negating their usability. The challenge is to design instruments with an error range that is both known and consistent, even over extended periods of time.

Brüel & Kjær A/S has been a leader in the field of sound and vibration measurement and analysis for over 40 years. Their customers include Airbus, Boeing, Ferrari, Bosch, Honeywell, Caterpillar, Ford, Toyota, Volvo, Rolls-Royce, Lockheed Martin, and NASA, just to name a few.

Because industry sound and vibration challenges are diverse—from traffic

and airport noise to car engine vibration, wind turbine noise, and production quality control, Brüel & Kjær must design microphones and accelerometers that meet a variety of different measurement standards. In order to meet these requirements, the company's R&D process includes simulation as a way to verify the precision and accuracy of their devices and test new and innovative designs.

⇒ DESIGNING AND MANUFACTURING ACCURATE MICROPHONES

Brüel & Kjær develops and produces condenser microphones covering frequencies from infrasound to ultrasound, and levels from below the hearing threshold to the highest sound pressure in normal atmospheric conditions. The range includes working standard and laboratory standard microphones, as well as dedicated microphones for special applications. Consistency and reliability is a key parameter in the development of all of

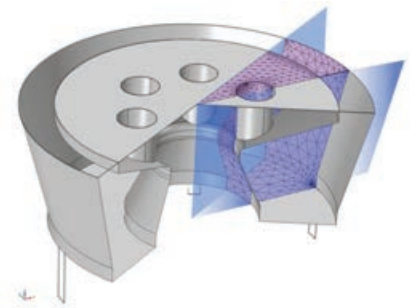

FIGURE 2. Geometry plot of the 4134 condenser microphone. The figure shows the mesh used in the reduced sector geometry, representing 1/12 of the total geometry.

Brüel & Kjær's microphones.

"We use simulation to develop condenser microphones and to ensure that they meet relevant International Electrical Commission (IEC) and International Organization for Standardization (ISO) standards," says Erling Olsen, development engineer in Brüel & Kjær's Microphone Research and Development department. "Simulation is used as part of our R&D process, together with other tools, all so that

we know that our microphones will perform reliably under a wide range of conditions. For example, we know precisely the influence of static pressure, temperature and humidity, and the effect of other factors for all of our microphones—parameters that would have been very difficult to measure were it not for our use of simulation.”

The Brüel & Kjær Type 4134 condenser microphone shown in Figure 1 is an old microphone that has been subject to many theoretical and practical investigations over time. Therefore, the 4134 microphone has been used as a prototype for developing multiphysics models of Brüel & Kjær condenser microphones. To analyze the microphone’s performance, Olsen’s simulations include the movement of the diaphragm, the electromechanical interactions of the membrane deformations with electrical signal generation, the resonance frequency, and the viscous and thermal acoustic losses occurring in the microphone’s internal cavities.

⇒ MICROPHONE MODELING

When sound enters a microphone, sound pressure waves induce deformations in the diaphragm, which are measured as electrical signals. These electrical signals are then converted into sound decibels. “Modeling a microphone involves solving a moving mesh and tightly coupled mechanical, electrical, and acoustic problems—something that could not be done without multiphysics,” says Olsen. “The models need to be very detailed because in most cases, large aspect ratios (due to the shape of the microphone cartridges) and small dimensions cause thermal and viscous losses to play an important role in the microphone’s performance.”

The model can also be used to predict the interactions that occur between the backplate and diaphragm. Among other things, this influences the directional characteristics of the microphone. “We used the simulation to analyze the bending pattern of the diaphragm,” says Olsen. For simulations such as thermal stress and resonance frequency, model symmetry was used to reduce calculation time (see Figure 2). The reduced model was also used to analyze the sound pressure

level in the microphone for sounds that are at a normal incidence to the microphone diaphragm (see Figure 3). However, when sound enters the microphone with non-normal incidence, the membrane is subjected to a nonsymmetrical boundary condition. This requires a simulation that considers the entire geometry in order to accurately capture the bending of the membrane (see Figure 4).

Simulation was also used to determine the influence of the air vent in the microphone for measuring low-frequency sounds. “We modeled the microphone with the vent either exposed to the external sound field, outside the field (unexposed), or without a vent,” says Olsen. “While the latter would not be done in practice, it allowed us to determine the interaction between the vent configuration and the input resistance results for different low-frequency behaviors. This is one of the most important things about simulation: We can make changes to the parameters of a model that move away from already manufactured devices, allowing us to test other designs and explore the limits of a device (see Figure 5).”

With simulation as part of the R&D process, Olsen and his colleagues are able not only to design and test some of Brüel & Kjær’s core products, but devices can also be created based on a specific customer’s requirements.

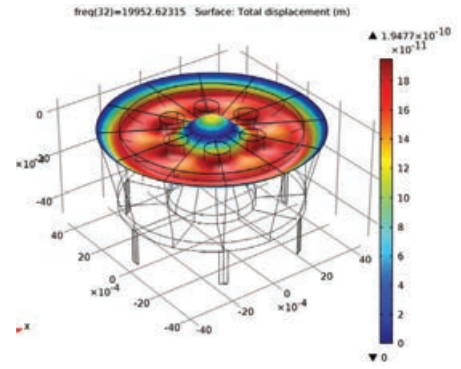

FIGURE 3. Representation of the sound pressure level below the diaphragm for normal incidence, calculated using the sector geometry. The membrane deformation is evaluated at $f = 20$ kHz.

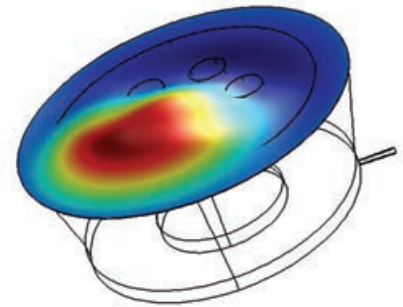

FIGURE 4. Simulation results showing the membrane deformation calculated for non-normal incidence at 25 kHz. Since the deformation is asymmetrical, this is calculated using the full 3D model.

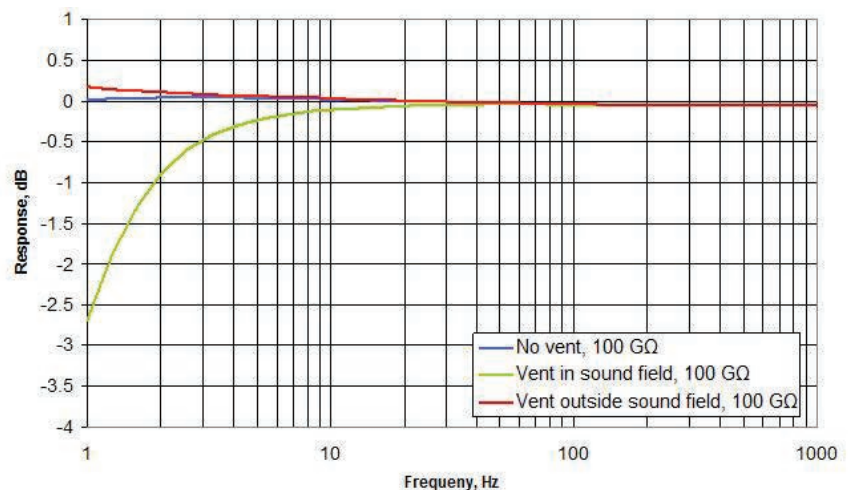

FIGURE 5. In the no-vent configuration, the sensitivity increase is due to the fact that the sound field becomes purely isothermal inside the microphone at very low frequencies. In the vent outside the sound field configuration, the curve initially follows the no-vent curve, but sensitivity increases further as the vent becomes a pressure release on the back of the diaphragm.

“With simulation, we can pinpoint approaches for making specific improvements based on a customer’s needs. Although microphone acoustics are very hard to measure through testing alone, after validating our simulations against a physical model for a certain configuration, we are able to use the simulation to analyze other configurations and environments on a case-by-case basis.”

⇒ VIBRATION TRANSDUCER MODELING

Søren Andresen, a development engineer with Brüel & Kjær, also uses simulation to design and test vibration transducer designs.

“One of the complications with designing transducers for vibration analysis is the harsh environments that these devices need to be able to withstand,” says Andresen. “Our goal was to design a device that has so much built-in resistance that it can withstand extremely harsh environments.”

Most mechanical systems tend to have their resonance frequencies confined to within a relatively narrow range, typically between 10 and 1000 Hz. One of the most important aspects of transducer design is that the device does not resonate at the same frequency as the vibrations to be measured, as this would interfere with the measured results. Figure 6 shows the mechanical displacement of a suspended vibration transducer, as well as a plot of the resonance frequency for the device.

“We want the transducer to have a flat response and no resonance frequency for the desired vibration range being measured,” says Andresen. “We used COMSOL to experiment with different designs in order to determine the combination of materials and geometry that produces a flat profile (no resonance) for a certain design. This is the region in which the transducer will be used.”

When designing the transducer, a

“With simulation, we can pinpoint approaches for making specific improvements based on a customer's needs.”

— ERLING OLSEN, DEVELOPMENT ENGINEER AT BRÜEL & KJÆR

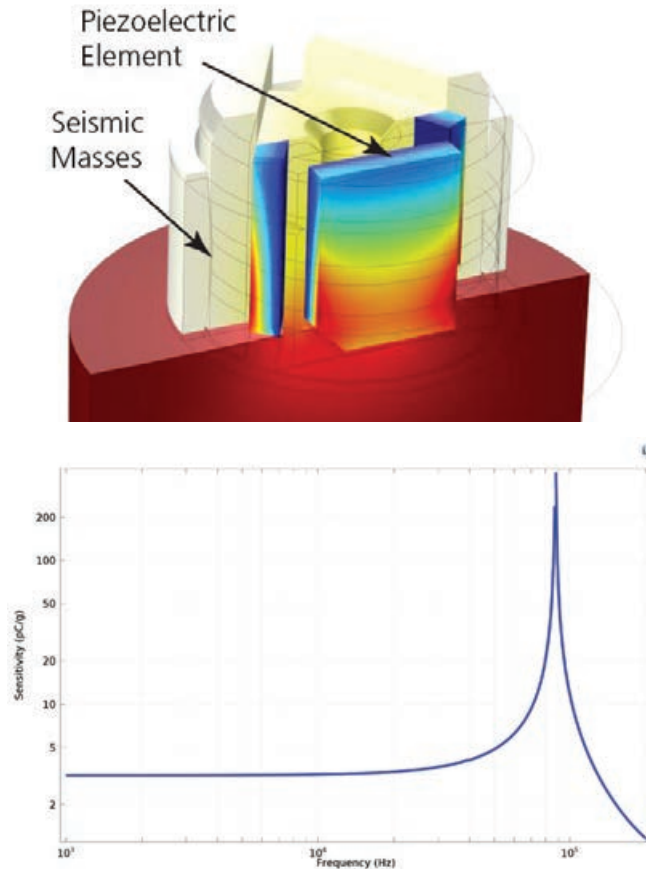

FIGURE 6. Simulation results of a suspended piezoelectric vibration transducer. Top: Mechanical deformation and electrical field in the piezoelectric sensing element and seismic masses. Bottom: Frequency-response plot showing the first resonance of the transducer at around 90 kHz. This device should only be used to measure objects at frequencies well below 90 kHz.

low-pass filter, or mechanical filter, can be used to cut away the undesired signal caused by the transducer resonance, if any. These filters consist of a medium, typically rubber, bonded between two mounting discs, which is then fixed between the transducer and the mounting surface.

“As a rule of thumb, we set the upper frequency limit to one-third of the transducer’s resonance frequency, so that we know that vibration components measured at the upper

frequency limit will be in error by no more than 10 to 12%,” says Andresen.

⇒ AS ACCURATE AND PRECISE AS POSSIBLE

While it may not be possible to design a perfect transducer or take an infallible measurement, simulation brings research and design teams closer than ever before by allowing them to quickly and efficiently test new design solutions for many different operating scenarios.

“In order to stay ahead of the competition, we need knowledge that is unique,” says Andresen. “Simulation provides us with this, as we can make adjustments and take virtual measurements that we couldn’t otherwise determine experimentally, allowing us to test out and optimize innovative new designs.” ❖

MULTIPHYSICS SOFTWARE MODELS MEAN FLOW-AUGMENTED ACOUSTICS IN ROCKET SYSTEMS

Combustion instability in solid rocket motors and liquid engines is a complication that continues to challenge designers and engineers. The adoption of a higher-fidelity modeling approach supported by multiphysics analysis provides greater insight and predictive ability.

by **SEAN R. FISCHBACH**

Many rocket systems experience violent fluctuations in pressure, velocity, and temperature originating from the complex interactions between the combustion process and gas dynamics. During severe cases of combustion instability, fluctuation amplitudes can reach values equal to or greater than the average chamber pressure. Large amplitude oscillations lead to damaged injectors, loss of rocket performance, damaged payloads, and, in some cases, breach of case or loss of mission.



The injector faceplate of the F1 engine that powered the Saturn V rocket.

Historic difficulties in modeling and predicting combustion instability have reduced most instances of rocket systems experiencing instability to a costly fix through testing (see Figure 1), or to scrapping of the system entirely.

“A more complete depiction of combustion instability oscillations is achieved when a global energy-based assessment is used.”

During the early development of rocket propulsion technology scientists and engineers were cued to the underlying physics at play through the measurement of vibrating test stands, observation of fluctuating exhaust plumes, and, most notably, the audible tones accompanying instabilities. These observations lead the pioneers of combustion instability research to focus their modeling efforts on the acoustic waves inside combustion chambers.

This focus on acoustics is quite logical given that the measured frequency of oscillation often closely matches the normal acoustic modes of the combustion chamber. But this narrow focus misses contributions made by rotational and thermal waves that are a direct result of, or closely coupled with, the acoustic wave. A more complete depiction of combustion instability oscillations is achieved when a global energy-based assessment is used.

Recent advances in energy-based modeling of combustion instabilities require an accurate determination of acoustic frequencies and mode shapes. Of particular interest are the acoustic mean flow interactions within the converging section of a rocket nozzle, where gradients of pressure, density, and velocity become large. The expulsion of unsteady energy through the nozzle of a rocket is identified as the predominate source of acoustic damping for most rocket systems.

Recently, an approach to address nozzle damping with mean flow effects was implemented by French². This new approach extends the work originated by

Sigman and Zinn³ by solving the acoustic velocity potential equation (AVPE) formulated by perturbing the Euler equations⁴.

Determining eigenvalues of the AVPE, where ψ is the complex acoustic potential, λ the complex eigenvalues, c the speed of sound, and M the Mach vector,

$$\nabla^2 \psi - \left(\frac{\lambda}{c}\right)^2 \psi - \mathbf{M} \cdot [\mathbf{M} \cdot \nabla(\nabla \psi)] - 2 \left(\frac{\lambda \mathbf{M}}{c} + \mathbf{M} \cdot \nabla \mathbf{M}\right) \cdot \nabla \psi - 2\lambda \psi \left[\mathbf{M} \cdot \nabla \left(\frac{1}{c}\right)\right] = 0$$

is considerably more complex than the traditionally used pressure-based wave equation,

$$\nabla \cdot \left(-\frac{1}{\rho} \nabla p\right) + \frac{1}{\rho c^2} \frac{\partial^2 p}{\partial t^2} = 0$$

and requires numerical approximations of the chamber flow field and eigenvalues.

⇒ MODELING CHAMBER GAS DYNAMICS

The latest theoretical models for oscillatory disturbances in high-speed flows require a precise determination of the chamber acoustic eigenmodes. But first, a simulation of the mean flow properties of the combustion chamber must be performed.

COMSOL Multiphysics® software provides a numerical platform for

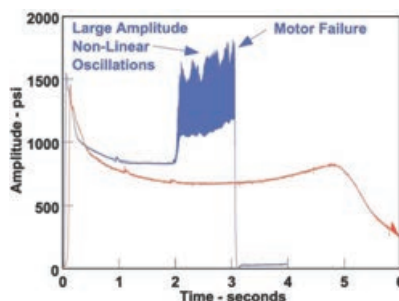

FIGURE 1. Pressure trace of a stable (red) and unstable (blue) solid rocket motor¹.

conveniently and accurately simulating both the chamber gas dynamics and internal acoustics. This finite element software package provides many predefined physics along with a generalized mathematics interface.

The present study employs the COMSOL finite element framework to model the steady flow-field parameters of a generic liquid engine using the High Mach Number Laminar Flow physics interface, which makes use of the fully compressible Navier-Stokes equations for an ideal gas together with conservation of energy and mass equations.

In order to account for the injection of hot gas due to the burning propellant, the injector face plate is modeled with a uniform inward flow of combusted propellant gas (see Figure 2). All other solid boundaries are modeled with the slip boundary condition, and the exit plane is modeled with the hybrid outflow condition, which means that both subsonic and supersonic flows are supported.

Results from the mean flow analysis are reviewed to ensure a valid and converged solution. Mean flow parameters such as pressure, density, velocity, and speed of sound are needed to model the AVPE. The values of the mean flow in the converging section of the nozzle, near the sonic choke plane, are of considerable interest. The sonic plane, where the Mach number is equal to 1, creates an acoustic barrier in the flow. In order to create an accurate geometry for the acoustic analysis, the sonic plane (pictured in magenta in Figure 3) is extracted from the mean flow analysis.

⇒ MODELING CHAMBER ACOUSTICS

The Coefficient Form PDE (Partial Differential Equation) mathematics interface of COMSOL Multiphysics is used to determine the complex eigenvalues of the AVPE. Mean flow terms in the AVPE are supplied by the solution from the mean flow analysis. Gas dynamics within the combustion chamber play a key role in defining the boundary conditions for the acoustic analysis. Within the converging and diverging section of the rocket nozzle, gradients of chamber pressure, velocity, and density grow theoretically infinite at the sonic plane where the Mach number is equal to 1. Downstream of the sonic plane, acoustic disturbances are convected with the mean flow at speeds greater than

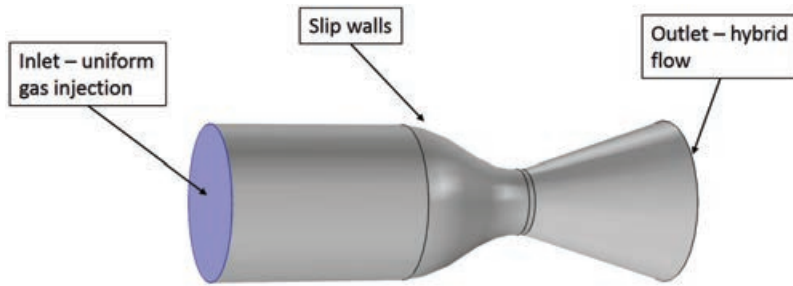

FIGURE 2. Simulated liquid engine geometry with boundary conditions.

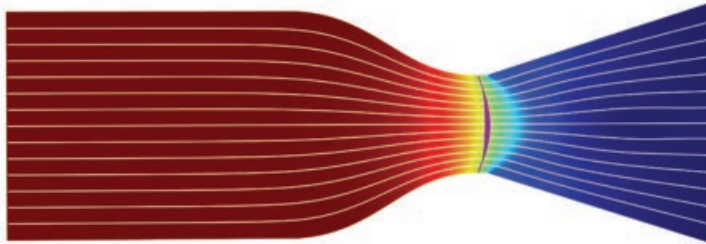

FIGURE 3. Velocity streamlines plotted over chamber pressure. The Mach 1 surface is plotted in magenta.

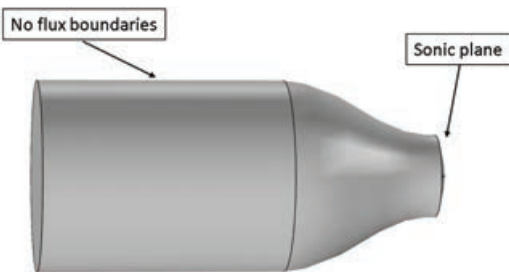

FIGURE 4. Acoustic analysis geometry with boundary conditions.

the speed of sound.

This condition prevents disturbances downstream of the sonic plane from propagating back upstream. The diverging section of the nozzle is acoustically silent and does not affect the chamber acoustics. The simulation geometry is truncated at the nozzle sonic line, where a zero flux boundary condition is self-satisfying (see Figure 4). The remaining boundaries are modeled with a zero flux boundary condition, assuming zero acoustic absorption on all surfaces.

The eigenvalue analysis produces complex eigenmodes and eigenvalues representing each acoustic mode and its complex conjugate. The real part of the complex eigenvalue represents the temporal damping of the acoustic

mode, with the imaginary part defining the frequency of oscillation. The complex eigenvectors represent the spatial amplitude and phasing of the acoustic wave.

Comparing the acoustic mode shapes derived using the classic homogeneous wave equation (Helmholtz equation) to those derived using the AVPE demonstrates the benefits of higher-fidelity models that correctly represent the underlying

physics (see Figure 5). Inclusion of mean flow terms in the AVPE accurately models the phase shift caused by the steady gas flow. Phasing is extremely important since combustion instability models make use of temporal and spatial integration of the acoustic eigenvectors.

Utilizing COMSOL Multiphysics to simulate the rocket gas dynamics and acoustic eigenmodes provides a more accurate mode shape over previous techniques. The higher-fidelity acoustic representation is easily incorporated into combustion instability models to give rocket designers and engineers greater predictive capabilities. The inclusion of damping devices, such as baffles, or changes in operating conditions, can

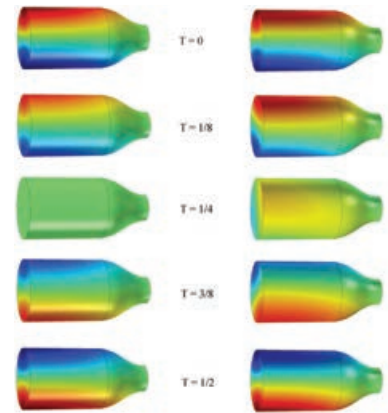

FIGURE 5. Comparison of the first tangential eigenmode calculated using the classic homogeneous wave equation (left), and the AVPE (right) of a half period (T) of oscillation.

now be more accurately modeled before testing.

⇒ CONTINUED WORK

A more complete depiction of combustion instability includes rotational oscillations and thermal oscillations in conjunction with chamber acoustics. Rotational oscillations occur as a direct result of the acoustic oscillation, where thermal waves can also be present in the absence of acoustic fluctuation. Continued work using COMSOL Multiphysics will focus on solving the viscous rotational wave that accompanies all acoustic oscillations. ❖

This article was written by Sean R. Fischbach, Marshall Space Flight Center/Jacobs ESSSA Group, MSFC, Huntsville, AL.

REFERENCES

1. F. S. Bloomshield, *Lessons Learned in Solid Rocket Combustion Instability*, 43rd AIAA Joint Propulsion Conference, AIAA-2007-5803, Cincinnati, OH, July 2007.
2. J. C. French, *Nozzle Acoustic Dynamics and Stability Modeling*, Vol. 27, Journal of Propulsion and Power, 2011.
3. R. K. Sigman and B. T. Zinn, *A Finite Element Approach for Predicting Nozzle Admittances*, Vol. 88, Journal of Sound and Vibration, 1983, pp. 117-131.
4. L. M. B. C. Campos, *On 36 Forms of the Acoustic Wave Equation in Potential Flows and Inhomogeneous Media*, Vol. 60, Applied Mechanics Reviews, 2007, pp. 149-171.



BEHIND THE RUMBLE AND ROAR OF MAHINDRA MOTORCYCLES

Mahindra Two Wheelers used multiphysics simulation to meet engine noise regulatory requirements in its high-end luxury motorcycles while maintaining customers' satisfaction.

by **VALERIO MARRA**

Mahindra Two Wheelers builds a wide range of scooters and motorcycles for the Indian market. Thanks to the adoption of numerical simulation tools early in the development cycle, drivers and passengers can enjoy great performance and mileage, along with a superior ride experience on tough Indian roads. Mahindra used multiphysics simulation to study the NVH (noise, vibration, and harshness) performance of the engine, intake, and exhaust systems of their motorcycles.

The knowledge gained from numerical simulation studies enabled their engineers to improve the structural design of their motorcycle engine and achieve desired noise levels. "COMSOL software helped us to significantly reduce the number of design iterations that we had to go through, thereby saving time," said Niket Bhatia, deputy manager R&D, Mahindra.

⇒ ACHIEVING OPTIMAL NOISE LEVELS

In an engine, there are many sources of noise, including the intake and combustion processes, pistons, gears, valve train, and exhaust systems. Combustion noise is due to structural vibrations caused by a rapid pressure rise within the cylinders.

These vibrations continue from the powertrain to the engine casings through bearings, radiating noise.

Acoustics analysis solely through physical testing can be an expensive and time-consuming process. The team at Mahindra decided to complement physical testing with acoustics modeling to analyze how the engine's structure might encourage noise radiation. The research goal was to find the parts of the engine that generate the most noise and come up with changes to the structure that could reduce it.

Using the COMSOL Multiphysics® software, the researchers performed an acoustic-radiation analysis of a single-cylinder internal combustion (IC) engine under combustion load. The engineers enclosed the engine skin in a computational domain surrounded by a perfectly matched layer (PML).

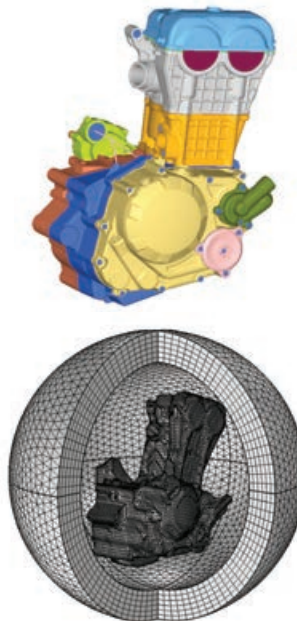

FIGURE 1. Top: engine CAD geometry. Bottom: meshed 3D model enclosed in a perfectly matched layer (PML).

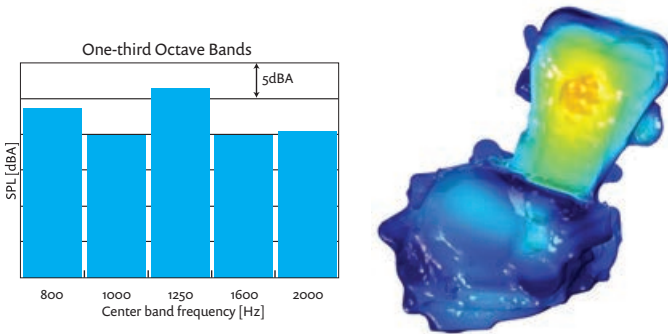

FIGURE 2. Left: One-third octave band plot. Right: 3D surface plot of the sound pressure level (SPL) simulation results.

PML's dampens the outgoing waves with little or no reflections (Figure 1). This allows for accurate results while reducing the size of the computational domain.

The team decided to focus their analysis in the 800 Hz -2000 Hz frequency range, as physical experiments indicated that the motorcycle's engine noise radiation under combustion load was dominant in that region of the acoustic spectrum. This choice allowed the team to save computational resources and better understand what areas radiate the most noise.

Based on this analysis, the sound pressure level (SPL) was studied and modifications, such as increasing rib height and wall thickness and strengthening the mounting location, were made to the cylinder head and block (Figure 2). By adjusting these parameters, reduction in SPL was achieved at the targeted frequency range.

⇒ REDUCING INTAKE STRUCTURAL NOISE

Both intake and exhaust noise are major contributors to pass-by-noise. Noise radiating from the air filter structure, usually made of plastic, is one of the major contributors to intake noise. An acoustic transfer function (ATF) analysis was carried out for the plastic air filter walls. The air filter structure was modified by providing ribs to improve the ATF (Figure 3). This helped in reducing the structural noise of the air filter (Figure 4).

⇒ ANALYZING TRANSMISSION LOSS TO IMPROVE MUFFLER SOUND

Regulatory requirements are always competing with customer demands for louder 'rumbling' from the muffler, as it is perceived as an important indicator of the motorcycle's power. Within the constraint of pass-by-noise, the challenge for Mahindra engineers was to increase the 'rumble' sound from their muffler at low frequencies while reducing the sound level for higher frequencies.

While attenuation of engine exhaust noise is the primary function of the muffler, factors such as the ability to provide low back pressure and meet pass-by-noise regulations also need to be considered. The performance of a muffler in an automotive exhaust system is characterized by three parameters: transmission loss, insertion loss, and radiated noise levels. Transmission loss is considered the most important parameter, and it is determined solely by the muffler design and is

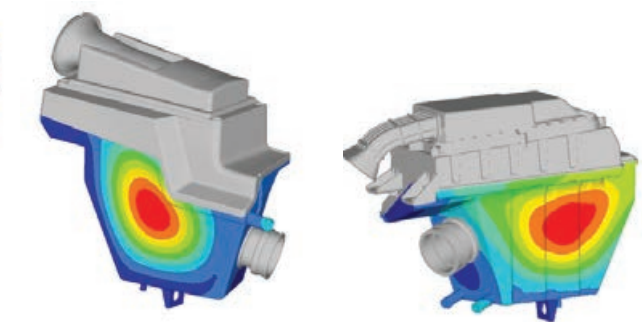

FIGURE 3. Air filter structure. Left: Original design. Right: Modified design, featuring ribs to improve the ATF.

independent of the pressure source. The challenge for the team at Mahindra was to predict the transmission loss for a motorcycle muffler and then optimize the loss to desired levels for a certain frequency range.

A muffler of a single cylinder motorcycle engine was considered for the analysis. Transmission loss analysis of the muffler was carried out using COMSOL Multiphysics. With the Acoustics Module, boundary conditions such as continuity and sound hard wall were applied at appropriate locations.

Perforations in pipes were defined by giving porosity details for the perforated area using a built-in transfer

impedance model. The inputs required for analysis were the area porosity, baffle and pipe thickness, and diameter of holes. For porous materials such as glass wool, flow resistivity was defined with a poroacoustic model available in the software. Unit pressure was given as input at the inlet and a plane wave radiation condition was applied to both inlet and outlet boundaries.

Based on the results, the muffler design was modified by increasing the pipe length inside the muffler. With the modified muffler, the team achieved reduced transmission loss at low frequencies (Figure 5). As a result, the desired outcome of increased noise levels at

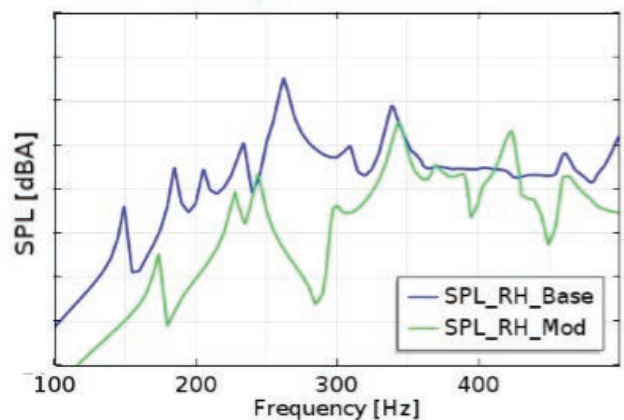

FIGURE 4. Simulation results show a reduction in the structural noise for the modified air filter design.

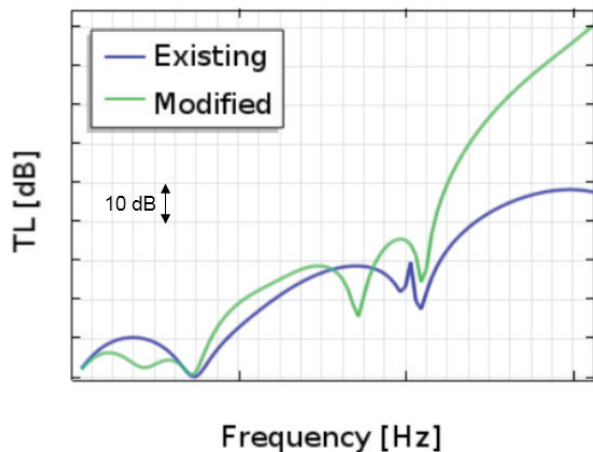

FIGURE 5. Transmission loss (TL) comparison between different designs. The modified design is characterized by reduced transmission loss at low frequencies and increased transmission loss at high frequencies. The modified design achieved the sought after ‘rumbling’ noise while meeting regulations.

“We created a simulation app using the Application Builder to compare analysis output files and plot the SPL data, which was a great time saver.

— ULHAS MOHITE, R&D MANAGER, MAHINDRA



FIGURE 6. With the Application Builder, Mahindra engineers created an easy-to-use simulation app that is used to compare analysis files and plot sound pressure level (SPL) data.

low frequencies, or the ‘rumbling’ noise, was achieved.

⇒ OPTIMIZATION EARLY IN THE DESIGN CYCLE LEADS TO COST AND TIME SAVINGS

“I personally really liked the software’s flexibility and available tools like the COMSOL API,” said Ulhas Mohite, manager of R&D, Mahindra. “It allowed us to carry out process automation using Java code which, while dealing with acoustic analysis for example, enabled us to use different meshes for different frequency steps to find the right compromise between simulation accuracy and computational time. It also enabled us to automatically export desired outputs such as surface SPL plots and far-field SPL data in the middle of the simulation run. This helped save a lot of time with respect to manual postprocessing and exporting the data.”

Mohite also found the Application Builder tool available in COMSOL extremely useful. “We created a simulation app (Figure 6) using the Application Builder to compare analysis output files and plot the SPL data, which was a great time saver.”

Analysis results proved to be very closely correlated

with physical experiment data. With simulation, the engineers at Mahindra were able to take corrective actions by carrying out structural modifications based on analysis results early in the design stage. This helped reduce both time and cost involved in product development. “When supported with experiments, these simulations lead us in the right direction to find an efficient solution to motorcycle noise issues,” concluded Bhatia. ❖

REFERENCES

1. Mohite, U., Bhatia, N., and Bhavsar, P., “An Approach for Prediction of Motorcycle Engine Noise under Combustion Load,” *SAE Technical Paper 2015-01-2244*, 2015, doi:10.4271/2015-01-2244.
2. Reducing Motorcycle Engine Noise with Acoustics Modeling, *COMSOL Blog*



FROM SPREADSHEETS TO MULTIPHYSICS APPLICATIONS, ABB CONTINUES TO POWER UP THE TRANSFORMER INDUSTRY

Companies developing new and improved power transformer equipment incur costs for prototyping and testing as they work to reduce transformer hum. At ABB, a team of engineers develops multiphysics simulations and custom-built applications to offer insight into their designs.

by **LEXI CARVER**

For everything from cooking to charging our phones, we rely every day on the electrical grid that powers buildings like homes, businesses, and schools. This complex network includes stations generating electric power, high-voltage transmission lines that carry electricity across large distances, distribution lines that deliver power to individual homes and neighborhoods, and the related

hardware used for power flow control and protection.

Among this equipment are power transformers for increasing and decreasing voltage levels in power lines that carry alternating current (see Figure 1). Power transfer with higher voltages results in lower losses and so is more desirable for transporting power long distances. However, such high voltage levels would pose a safety hazard at

either end of the lines, so transformers are used to increase voltage levels at the power feed-in point and decrease them close to neighborhoods and buildings.

But transformers come with noise, often manifested as a faint humming or buzzing that can be heard when walking nearby. Although it is impossible to completely silence them, regulations require adherence to safe sound levels, and good product design can minimize



FIGURE 1. Photo of transformer equipment for high-voltage power lines.

these acoustic effects.

One of the biggest manufacturers of transformers used around the world, ABB (headquartered in Zürich, Switzerland), has used numerical analyses and computational applications in order to predict and minimize the noise levels in their transformers. Through the COMSOL Multiphysics® simulation software and its Application Builder, they have run virtual design checks, tested different configurations, and deployed their simulation results through customized user interfaces built around their models.

⇒ **SILENCING SOUND FROM SEVERAL SOURCES**

Transformer noise often comes from several sources, such as vibrations in the transformer core or auxiliary fans and pumps used in the cooling system. Each of these sources needs to be addressed differently to reduce noise.

ABB’s transformers comprise a metal core with coils of wire wound around different sections, an enclosure or tank to protect these components, and an insulating oil inside the tank (see Figure 2, top). Passing alternating current through the windings of one coil creates a magnetic flux that induces current in an adjacent coil. The voltage adjustment is achieved through different numbers of coil turns.

Because the core is made of steel, a magnetostrictive material, these magnetic fluxes — which alternate direction — cause mechanical strains. This generates vibrations from the quick growing and shrinking of the metal. These vibrations travel to the tank walls through the oil and the clamping points that hold the inner core in place, creating an audible hum known as core noise (see Figure 2, bottom).

In addition to the core noise, the alternating current in the coil produces Lorentz forces in the individual windings, causing vibrations known as load noise that add to the mechanical energy

transferred to the tank.

With these multiple sources of noise and the interconnected electromagnetic, acoustic, and mechanical factors at play, engineers at the ABB Corporate Research Center (ABB CRC) in Västerås, Sweden needed to understand the inner workings of their transformers in order to optimize their designs for minimal transformer hum.

⇒ **COUPLING ACOUSTIC, MECHANICAL, AND ELECTROMAGNETIC EFFECTS ALL IN ONE**

“We chose to work with COMSOL Multiphysics because it allows us to easily couple a number of different physics,” said Mustafa Kavasoglu, scientist at ABB CRC. “Since this project required us to model electromagnetics, acoustics, and mechanics, COMSOL® software was the best option out there to solve for these three physics in one single environment.”

Kavasoglu; Dr. Anders Daneryd, principal scientist; and Dr. Romain

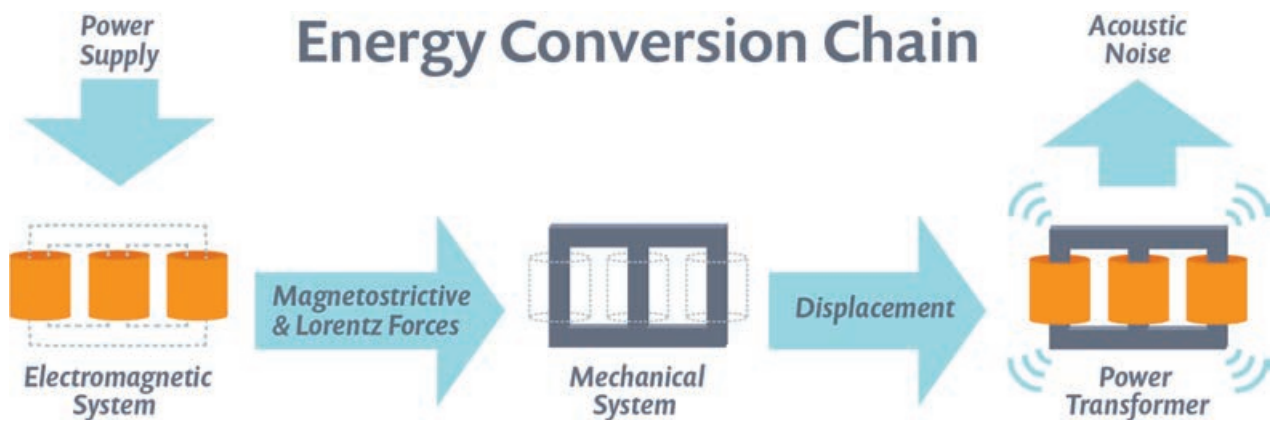
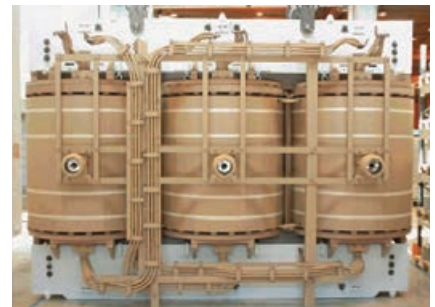
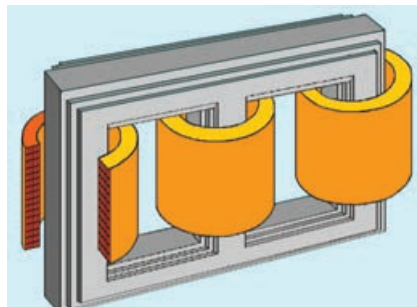

FIGURE 2. Top left: CAD model of the active part of a three-phase transformer with windings mounted around the core. Top right: The active part of a power transformer that is placed in a tank filled with oil. Bottom: The energy conversion chain for core noise and load noise generation (magnetostriction in the core and Lorentz forces in windings).

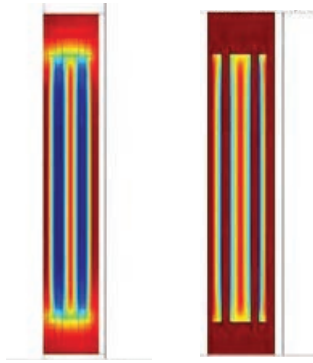

FIGURE 3. Simulation results showing the magnetic flux density (left) and Lorentz forces (right) in the transformer coil windings.

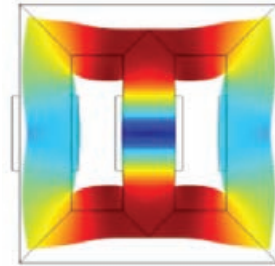
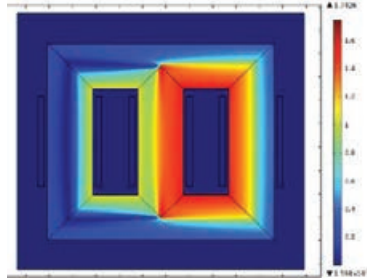

FIGURE 4. Left: COMSOL® software results showing levels of magnetic flux in the steel. Right: Results showing the resonance of the core. Deformations are exaggerated for visibility.

Haettel, principal engineer, from the ABB CRC team working with transformer acoustics. Their objective was to create a series of simulations and computational apps to calculate magnetic flux generated in the transformer core and windings (see Figure 3, left), Lorentz forces in the windings (see Figure 3, right), mechanical displacements caused by the magnetostrictive strains, and the resulting pressure levels of acoustic waves propagating through the tank.

They work closely with the Business Unit ABB Transformers, often relying on the experience and expertise of Dr. Christoph Ploetner, a recognized professional in the field of power transformers, to ensure that they satisfy business needs and requirements.

One simulation models the noise emanating from the core due to magnetostriction. The team began with an electromagnetic model to predict the magnetic fields induced by the alternating current, and then the magnetostrictive strains in the steel.

Their geometry setup included the steel core, windings, and an outer domain representing the tank. “We obtained the displacement from the

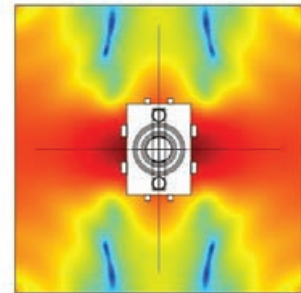
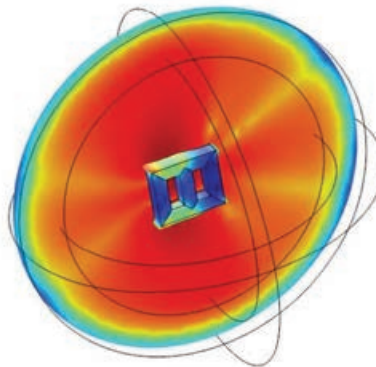

FIGURE 5. Results of the acoustic analysis showing the sound pressure field around the core (left) and around the transformer (right).

magnetostrictive strains, then calculated the resonance for different frequencies using a modal analysis,” said Kavasoglu (see Figure 4). “Resonances are easily excited by the magnetostrictive strains and cause high vibration amplification at these frequencies.”

They were then able to predict the sound waves moving through the oil and calculate the resulting vibrations of the tank, implying sound radiation into the surrounding environment (see Figure 5).

They also simulated the displacements of the coil windings that cause load noise

and determined the surface pressure on the tank walls due to the resulting sound field (see Figure 6).

Including parametric studies that illustrated the complex relationships between design parameters (such as tank thickness and material properties) and the resulting transformer hum made it possible to adjust the geometry and setup of the core, windings, and tank to minimize the noise.

⇒ **SPREADING SIMULATION CAPABILITIES THROUGHOUT ABB**

The CRC team continues to use the COMSOL software to not only improve their understanding and their models, but to extend their knowledge to the rest of ABB’s designers and to the business unit. Using the Application Builder in COMSOL Multiphysics, they have begun creating apps from their multiphysics models, which can be easily customized to suit the needs of each department.

“We’ve also been using the COMSOL Server™ license to distribute our app to other offices for testing, which makes it easy to share it. This worldwide license is great; with a global organization, we expect users in our other locations around the world to benefit from these apps.”

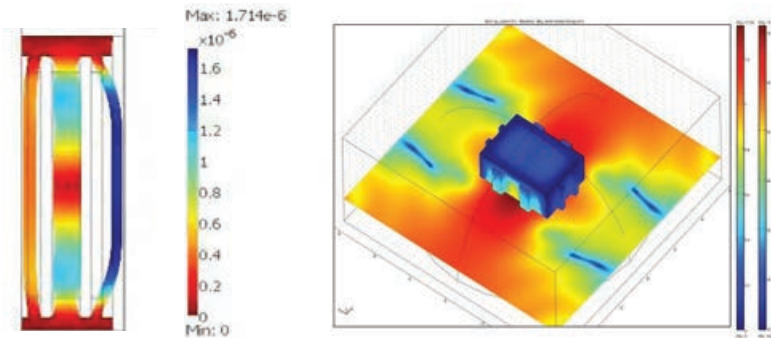

FIGURE 6. Left: Simulation results showing the displacement of the windings. Deformations are exaggerated for visibility. Right: Results showing the sound pressure levels outside the tank and the displacement of the walls.

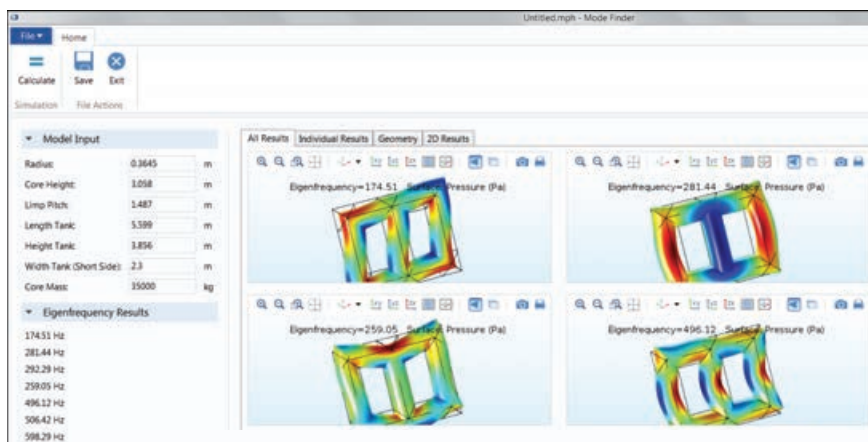

FIGURE 7. Cropped screenshot of the first simulation app created for calculating eigenfrequencies of the transformer core. At left, a tab in the app shows the model inputs; at right, results are shown for the calculated eigenfrequencies. Deformations are exaggerated for visibility.

These simulation applications simplify testing and verification for the designers and R&D engineers: “The designers have been using tools based on statistics and empirical models. We are filling the gaps by deploying simulation apps. The Application Builder allowed us to give them access to finite element analysis through a user interface without them needing to learn finite element theory,” Haettel explained.

One application (see Figure 7) calculates the specific eigenfrequencies of the transformer core that can imply noise-related issues due to frequencies that fall within the audible range. This app includes both the physics model developed in the COMSOL® software and custom methods written in Java® code, programmed within the Application Builder.

“Our designers use standard

spreadsheets that work well for the transformers they build frequently. But when new designs or different dimensions are introduced, they may run into problems with this approach, like error outputs showing less accurate data for noise levels. This can become quite costly if additional measures to reduce noise are required on the completed transformer,” Haettel continued.

“Besides the cost aspect, there is the time aspect. The new app will make the designers’ job easier and more efficient by using the precision of an FEA code.”

The custom application adds a level of convenience by letting users check how certain combinations of geometry, material properties, and other design parameters will affect the resulting transformer hum. “We’ve been deliberate about selecting which parameters we provide access to —

focusing on the ones that are most important,” Kavasoglu added.

With the wide range of industrial applications for which ABB designs transformers, this flexibility is immensely helpful for their design and virtual testing process. “ABB produces transformers for every industrial need. At the moment we’re focusing on AC large power transformers commonly used by power companies that transmit and distribute electricity throughout cities,” he explained.

“But the work we’re doing can be translated to any type of transformer, and of course if we receive a specific request, we adapt the app to that need. This allows us to easily do additional development work. The Application Builder has made the transfer of knowledge and technology much easier.

“We’ve also been using the COMSOL Server™ license to distribute our app to other offices for testing, which makes it easy to share it. This worldwide license is great; with a global organization, we expect users in our other locations around the world to benefit from these apps.” With a local installation of COMSOL Server, simulation specialists can manage and deploy their apps, making them accessible through a client or web browser.

The team is focusing on a second application that will calculate load noise. Once deployed to the business unit, this application will further remove the burden of tedious calculations, allowing designers and sales engineers to run more virtual tests without needing to work with a detailed model, and enable ABB to more quickly and easily produce the world’s best transformers. ❖

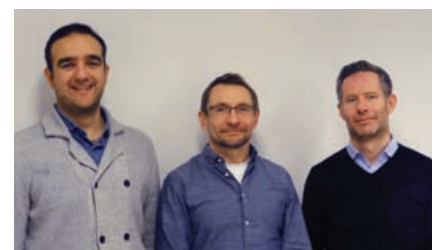

Left to Right: Mustafa Kavasoglu, Romain Haettel, and Anders Daneryd of ABB CRC.

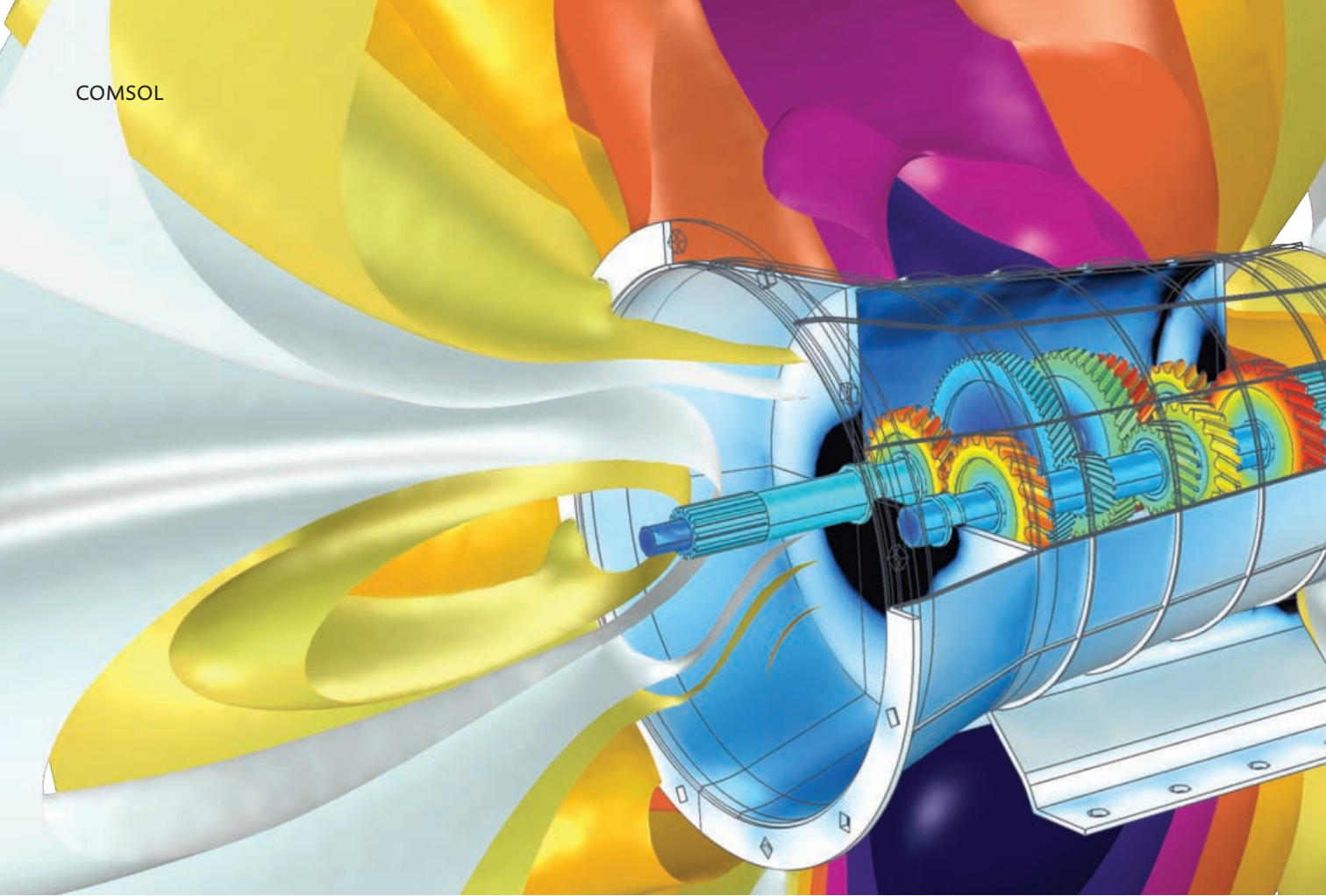

MODELING VIBRATION AND NOISE IN A GEARBOX

Predicting the noise radiation from a dynamic system like a gearbox provides designers with insight early in the design process.

by **PAWAN SOAMI**

A gearbox, used to transfer power from the engine to the wheels, radiates noise for two reasons. First, the gears, which transmit power from one shaft to another, exert undesired lateral and axial forces on bearings and the housing. Second, the flexibility of the different components of the gearbox, including bearings and housing, can result in vibration.

In a gearbox, varying gear mesh stiffness causes sustained vibration that is transmitted to its housing, which in turn vibrates and transmits energy

to the surrounding fluid; gearbox oil, for example; resulting in the radiation of acoustic waves. In order to accurately model and simulate this coupled phenomena, a contact analysis, multibody dynamics analysis, and acoustic analysis should be performed.

The gearbox considered in this analysis has a drive shaft connected to the counter shaft and five pairs of helical gears (Figure 1). The gears are different sizes but are made of the same material: a structural steel.

⇒ CONTACT ANALYSIS OF THE GEAR MESH

The mesh of gears, which is assumed to be elastic, is a source of sustained vibration. As such, the stiffness of the gears must be evaluated at different positions. As gear teeth deform during operation, a stationary parametric analysis is performed to determine the stiffness variation over a gear mesh cycle. A penalty contact method is used and constraints are defined to account for the twisting of gears leading to contact forces.

Simulation results showing the distribution of von Mises stress in a gear pair indicate high stress values at contact points as well as at roots of the teeth (Figure 2). Using simulation, it is possible to see the variation of gear mesh stiffness with shaft rotation, as shown in Figure 2.

⇒ MULTIBODY ANALYSIS OF SHAFTS, GEARS, AND HOUSING

The multibody analysis is performed in the time domain for one full revolution of the

drive shaft using the gear mesh stiffness predicted by the contact analysis. This analysis is needed to compute the dynamics of gears and the resulting vibrations of the housing. In this case, the analysis is performed at an engine speed of 5000 rpm and output torque of 2000 N·m. The shafts and gears are assumed to be rigid except for the gear mesh, for which the stiffness is taken from the previous contact analysis. The housing is comprised of steel and is considered elastic.

The von Mises stress distribution in the housing due to the forces transmitted by the drive shaft and the counter shaft can be seen in Figure 3. The normal acceleration of the vibrating housing, which is responsible for the noise radiation, is also shown in Figure 3.

Figure 4 shows the time history and frequency spectrum of the normal acceleration at the top of the housing. The dominant frequencies at which the housing is vibrating are between 1500 Hz and 2000 Hz. The housing deformation is shown in Figure 5.

⇒ **ACOUSTIC ANALYSIS OF NOISE RADIATING FROM THE HOUSING**

The normal acceleration experienced by the housing and predicted by the multibody analysis is used as the noise source in the acoustic analysis. The simulation, performed in the frequency domain, predicts the sound pressure level outside the gearbox. As the normal acceleration values are in the time

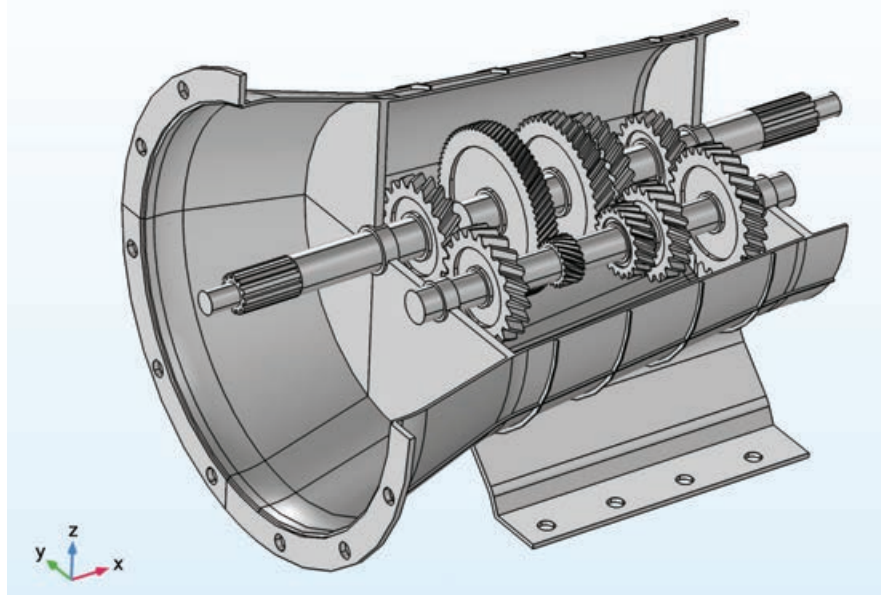

FIGURE 1. Model geometry of a 5-speed synchromesh gearbox for a manual transmission vehicle. Only selected parts of the gearbox considered in the multibody analysis are depicted.

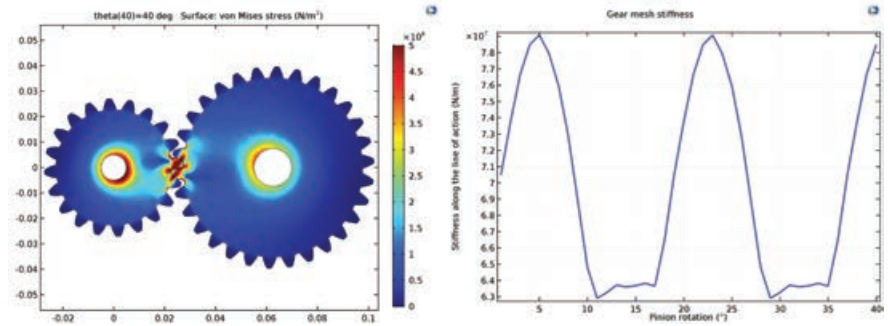

FIGURE 2. Left: von Mises stress distribution in a gear pair. Right: Variation of gear mesh stiffness with shaft rotation.

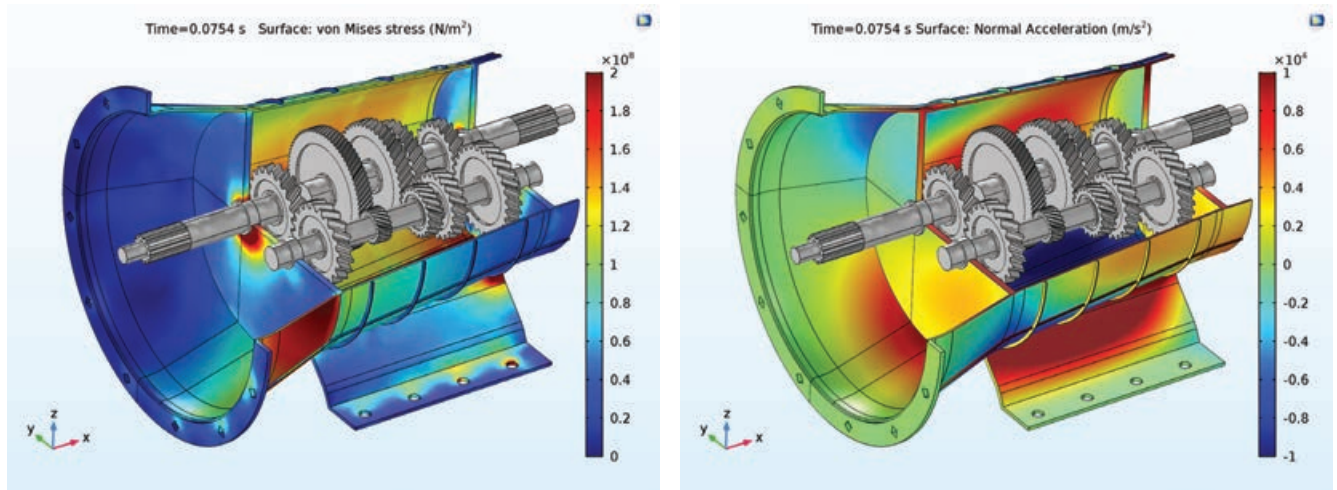

FIGURE 3. Left: von Mises stress distribution in the housing. Right: Normal acceleration of the housing.

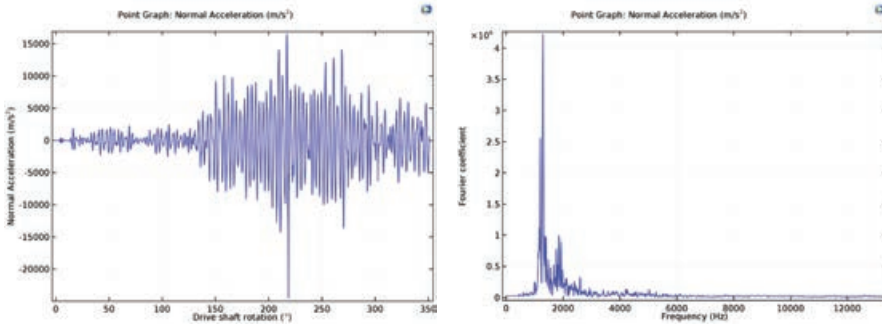

FIGURE 4. Normal acceleration at the top of the housing. Left: Time history. Right: Frequency spectrum.

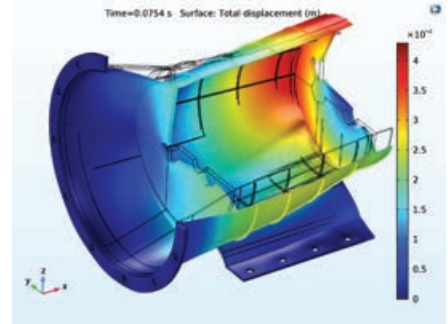

FIGURE 5. Housing deformation magnified 200 times.

domain, a forward FFT (fast Fourier transform) is used to convert them to the frequency domain. An air domain encloses the gearbox where the acoustic pressure is computed (Figure 6). To reduce the size of the computational domain without affecting the accuracy of the results, a spherical wave radiation condition is applied on the exterior boundaries of the air domain to allow outgoing acoustic waves to leave the modeling domain with minimal reflections.

The sound pressure level (SPL) on the housing surface and in the near field are shown in Figure 7. SPL can also be plotted in the far-field, as shown in Figure 8. Far-field plots in different planes and at a distance of 1 m give an idea of the dominant directions of noise radiation at the selected frequency.

⇒ CONCLUDING REMARKS

For simulating the vibration and noise generated, a multibody-acoustic interaction modeling approach is adopted. This technique can be used early in the design process of the gearbox,

thus improving the design in such a way that the noise radiation is minimized for different operating conditions. ❖

RESOURCES

- Using Software For Gearbox Noise Prediction, Auto Tech Review, June 2017
- How to Model Gearbox Vibration and Noise in COMSOL Multiphysics®, COMSOL Blog
- Modeling Vibration and Noise in a Gearbox, COMSOL Application Gallery

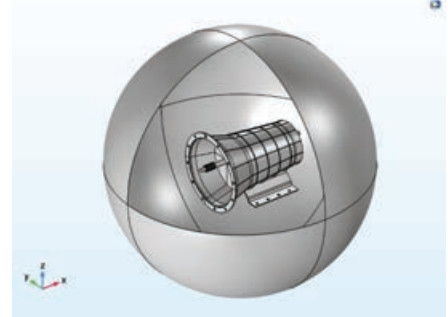

FIGURE 6. Air domain enclosing the gearbox used for the acoustic analysis.

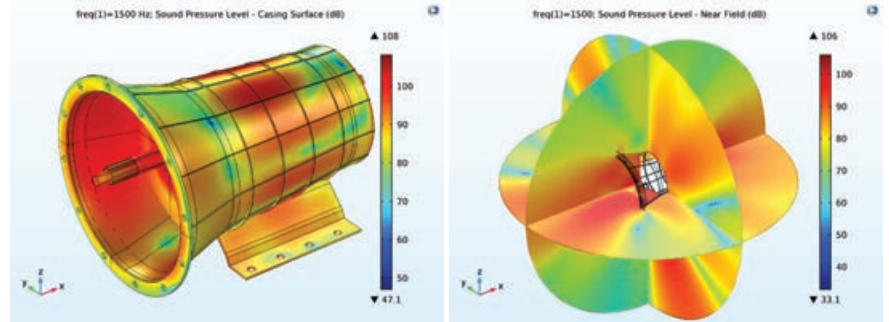

FIGURE 7. Sound pressure level at 1500 Hz. Left: Housing surface. Right: Near-field region.

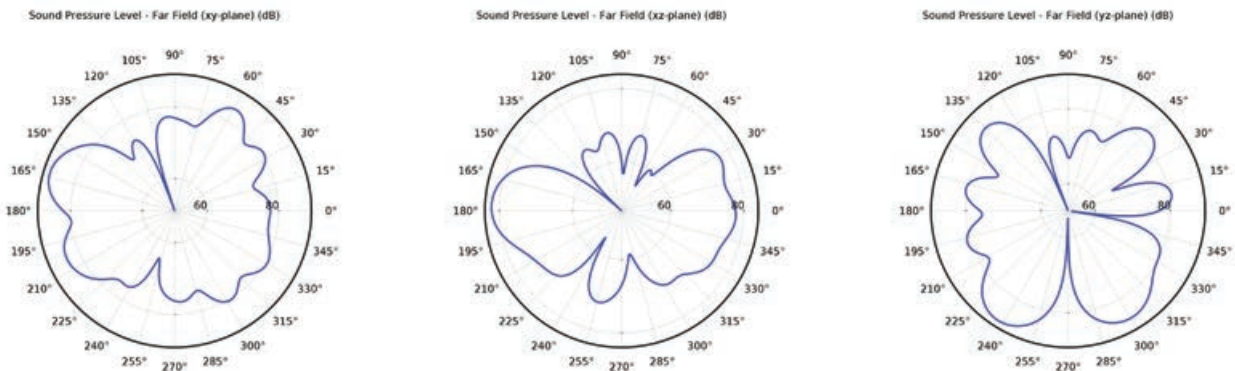

FIGURE 8. Far-field SPL (dB) in the x-y, x-z, and y-z planes, respectively, at a distance of 1 m at 1500 Hz.

Manipulate and Control Sound: How Mathematical Modeling Supports Cutting-Edge Acoustic Metamaterials Research

From consumer audio to ultrasound imaging, the implications of research into metamaterial structures for acoustic cloaking are far-reaching and fascinating. Researchers are using mathematical modeling to design acoustic metamaterials by combining transformation acoustics and highly anisotropic structures.

by **GEMMA CHURCH AND VALERIO MARRA**

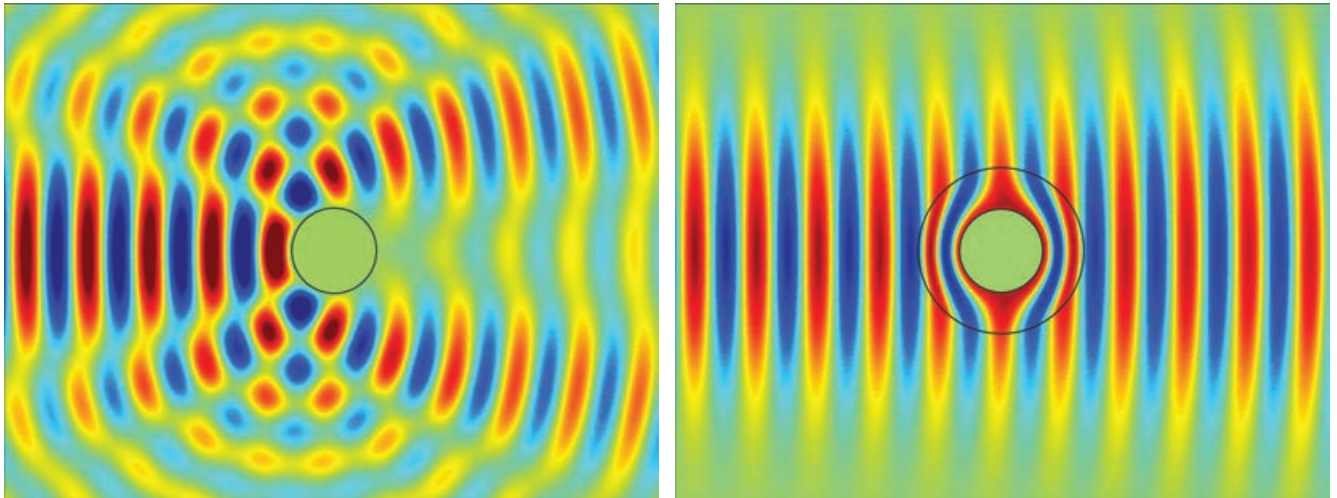

FIGURE 1. Controlling acoustic wave scattering from an object. Left: The scattering of a wave incident from the left from a rigid object is obvious: the reflection is quasi-specular, the shadow is deep, and a portion of wave power is spread in all directions. Right: Surrounding the same object with an ideal cloaking shell shows the absence of both reflection and shadow, while power is transmitted around the metamaterial object with virtually no losses.

Metamaterials are Man-made, specially fabricated materials featuring properties never found in nature, such as zero or even negative refractive index. The result is the creation of cutting-edge designs and functionality, such as superlenses and sound absorbers. Recent research efforts have turned to the arbitrary manipulation of sound waves using metamaterial devices, including making an object acoustically invisible.

The research has been a success. Using little more than a few perforated sheets of plastic and a staggering amount of mathematical modeling and numerical simulation work, engineers at Duke University have demonstrated the world's first 3D acoustic cloak. The device bends sound waves smoothly around an object, fills in the shadow and gives the impression the waves went straight

through the surrounding air.

Acoustic invisibility is just one aspect of the broad concept of transformation acoustics, in which carefully designed materials can deform or control sound waves in almost arbitrary ways. From sci-fi to mundane, there are many possible applications of this technological breakthrough.

⇒ DESIGNING SILENT METAMATERIALS

Duke University, alongside MIT, University of California, Berkeley, Rutgers University, and the University of Texas at Austin, forms part of a five-year research program sponsored by the US Office of Naval Research to develop new concepts for acoustic metamaterials with effective material parameters that can be fabricated in the real world.

Steve Cummer, professor of electrical and computer engineering at Duke University, said: "Mathematical models are the starting point. The acoustic metamaterial designs are optimized through numerical simulations, which we then translate into modern fabrication techniques and experimentally test."

"COMSOL makes it so easy and relatively straightforward to manipulate the material properties and the underlying dynamic equations."

— STEVE CUMMER, ELECTRICAL AND COMPUTER ENGINEERING DEPARTMENT, DUKE UNIVERSITY

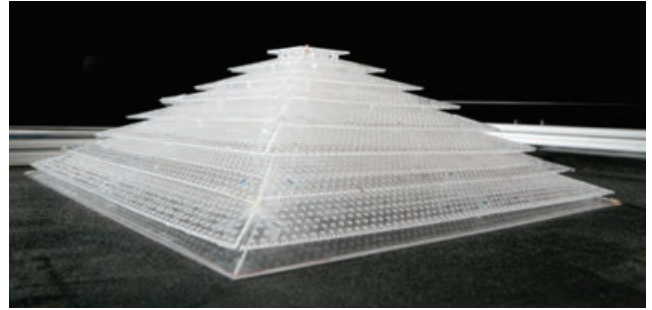
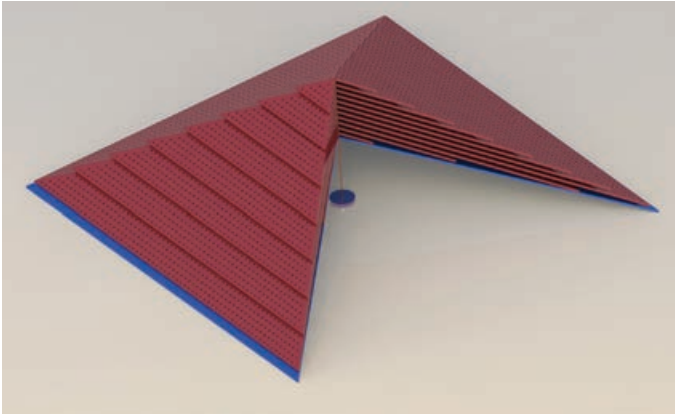

FIGURE 2. Design (left) and constructed version (right) of the pyramid-shaped 3D acoustic cloaking shell.

One focus of the group's current research efforts is on developing acoustic metamaterial structures that can be used in water-based environments, including the human body, to arbitrarily transform and control incoming sound waves. Acoustic cloaking structures (Figure 1) have proven a useful testbed for demonstrating the arbitrary control enabled by transformation acoustics. Designing for aqueous environments represents a shift in metamaterial research, which has evolved from electromagnetic cloaking and transformation optics, to acoustic cloaking and transformations in 2D and then 3D structures in air.

COMSOL Multiphysics® software has been a vital commodity at every stage of the research, going back to the very early days of electromagnetic cloaking. Cummer said: "In the first paper where we showed simulations of electromagnetic cloaking using real electromagnetic material parameters, we used COMSOL® software specifically because it was one of the only electromagnetic software tools that had the ability to accommodate arbitrarily anisotropic electromagnetic material parameters."

To attack the acoustics problem, the researchers began with deriving the needed material properties. Cummer explained: "To arbitrarily control sound using transformation acoustics, we first apply a coordinate transformation to describe how you would like to bend or twist or deform the sound field in a particular device. Once you've defined that coordinate transformation, then you can derive the effective material parameters you need to create that particular

deformation of the sound field."

That resulting set of material parameters is almost always anisotropic, which means the material properties behave differently in different directions. To handle this the researchers needed to be able to change the equations representing the physics being simulated. "COMSOL makes it so easy and relatively straightforward to manipulate the material properties and the underlying dynamic equations. This was really important because we could add that one extra twist of the anisotropy to the model and start simulating some of the designs that we were exploring within the transformation acoustics approach," Cummer added.

The resulting real-world designs have been very successful and their performance matched the simulations "astonishingly well", according to Cummer. "The gold standard in metamaterials publications these days, to show whether a structure works the way you want it to and produces the physics you want it to, is to take a measurement of the full sound field produced by the acoustic metamaterial and compare that to the simulation," he added.

COMSOL Multiphysics® software is able to consistently achieve such agreement, even when human error has tried to derail the research. In an earlier project, a 2D acoustic cloaking shell featuring a series of tiny holes was

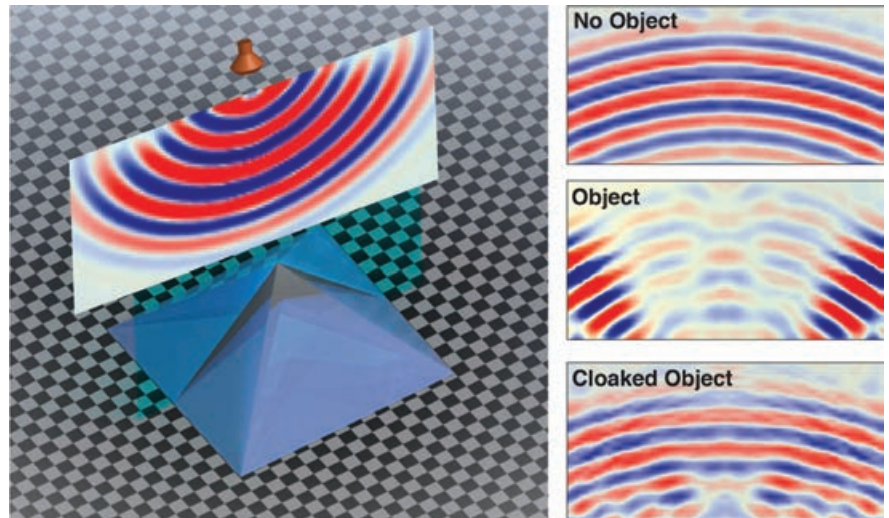

FIGURE 3. (left) To test the metamaterial shell, a sound pulse is launched in three different configurations and the reflected sound pulse is measured with a scanned microphone. (right) The reflected acoustic pulse from the test object is dramatically different than that with no object. When the cloaking shell is placed on the object, the reflected pulse is almost identical to that with no object, demonstrating its invisibility to sound.

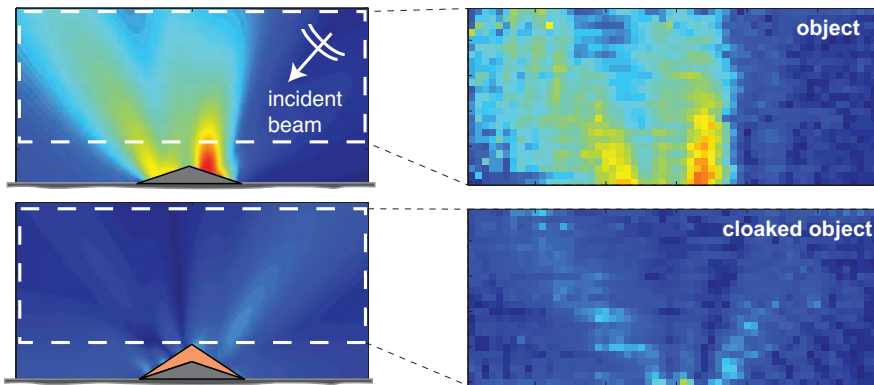

FIGURE 4. The good agreement between simulations (left) and measurements (right) of the scattered acoustic fields not only shows the degree of acoustic cloaking of the object, but confirms that COMSOL accurately predicts the performance of the fabricated device.

designed and built, but the experiments did not match the simulations. The team was flummoxed and could not see any viable reason for the discrepancy. They suddenly realized that holes in the structure were the wrong size due to a mix up during its construction.

Cummer said: “The efficiency of COMSOL has been pretty critical in our work because we can do numerical simulations of both the idealized parameters and then of the full structure that we would actually build, to confirm that they behave the same way.”

⇒ FABRICATING AND TESTING AN ACOUSTIC METAMATERIAL

The design of a 3D acoustic cloaking shell employed the same basic perforated plate structure in a pyramidal shape (Figure 2) under which an object could be hidden from sound waves. The structure may at first appear to be relatively simple in its design, but many factors are balanced to achieve the desired acoustic transformation, including the hole diameter, the spacing between the plates, and the angle of the plates. All of these parameters combine to give just the right amount of acoustic anisotropy to make the structure work.

This pyramid structure was the world’s first 3D acoustic cloak, and laboratory measurements confirmed that it is capable of rerouting sound waves to create the impression that both the cloak and anything beneath it are not there (Figure 3). The device works in all three dimensions, no matter which direction

the sound is coming from or where the observer is located, and holds potential for future applications such as sonar avoidance and architectural acoustics.

Given the necessary thickness of the acoustic metamaterial shell, the latter is the more plausible option, where such acoustic cloaking devices could be used to optimize the sound in a concert hall or dampen it in a noisy restaurant environment, for example. Cummer said: “The cloaking material is not just magic paint you can spray onto something. Generally speaking, that’s not the way that these kind of ideas can be deployed in practice.”

Beyond the design stage, modeling and simulation have been used to predict the quantitative performance of metamaterial shells like this, including a detailed analysis of the scattering from a 2D cloaking shell implementation (Figure 4). Not only does this show how much the scattered field is reduced by the shell, but COMSOL accurately predicts the amount of scattering reduction given design tradeoffs made in the fabrication of the acoustic metamaterial.

⇒ FROM AIR TO WATER, DIFFERENT MEDIUM, NEW CHALLENGES

Attention has now shifted to getting acoustic metamaterials to work in an aqueous environment, such as underwater or inside the human body. Multiphysics modeling is used as the primary design tool to first map the previously designed structures and run simulations in order to test how they will

perform in water. The move from air to water is more difficult than it seems.

The problem is that the mechanical properties of air are dramatically different from those of water. Cummer explained: “That’s why in air we can get away with building acoustic metamaterials in plastic, or whatever solid is convenient, as the solid can act essentially as a perfectly rigid structure to control the sound field flow. It doesn’t really matter what it is made of.”

But the mass density and compressional stiffness of water are not so different from solid materials. “When sound waves hit a solid structure in water, the mechanical properties of that solid start to matter a lot. We need to come up with new techniques in the design phase to be able to control how that sound wave energy interacts with the solid so that we can maintain the properties we want,” he added.

“The ability to easily merge acoustics and structural mechanics is essential, especially when we’re dealing with structures in water where we can’t ignore the mechanical responses of the solid material that we’re using to build the metamaterial. In airborne acoustics, we can get away with treating the solid as a material that is infinitely rigid, which is easy and computationally efficient, but for the water-based material it is essential to be able to consider fluid-structure interaction, which is easy with COMSOL.”

The leap from research into commercially viable acoustic metamaterial structures is far from simple and means such structures must be able to be fabricated reliably and repeatably. Cummer concluded: “The next step to creating any acoustic metamaterial is that it is able to hit specific quantitative metrics. That means we have a more complicated design process, but that’s exactly what COMSOL is designed to do. [It allows] much more design iteration and clever use of optimization to identify degrees of freedom in the design that can be manipulated to then hit those specific numerical targets. That’s definitely the key going forward in transitioning these ideas from proof of concept demonstrations to something that’s actually practical and deployable in the real world.” ❖

Shake, Rattle, and Roll

Norwegian researchers are tracking how low-frequency sound waves travel within buildings so that they can recommend design adjustments to alleviate annoying vibrations.

by **JENNIFER HAND**

Anyone who has slept near an airport will know the sensation — an early morning flight wakes you from sleep, not only because the engine is noisy but also because everything around you seems to be shaking. Likewise, people living near wind turbines, military sites, or hospitals with helicopter landing pads often complain that windows rattle and everyday objects buzz when there is external noise. More puzzling for them is the fact that even when they can discern no sound, they may still notice irritating vibrations.

If the response of the sound is 20 vibrations per second (20 Hz) or less, it is described as infrasound, meaning that the original sound is not usually audible to the human ear. The effects, however, are very easy to detect. As waves hit windows, spread to the floor, and affect internal walls, they induce a noticeable indoor vibration. Low-frequency sound waves are notorious for their potential to create annoying disturbances.

⇒ **LOW-FREQUENCY SOUND WAVES IN BUILDINGS**

Noise is part of modern life and there are formal standards that use sound pressure level measurements to recognize high-frequency sound waves at levels of sensitivity, intrusion, and danger for humans. According to Finn Løvholt of the Norwegian Geotechnical Institute (NGI), the generation of building vibration due to infrasound is an area of research that has not been explored extensively. For this reason, NGI, an international center for research and consulting within the geosciences, has been running investigative programs for several years on behalf of the Norwegian Defence Estate Agency.

“Low-frequency sound encounters less absorption as it travels through the air than higher-frequency sound, so it persists for longer distances. The amount of sound transmitted

“We have never achieved this level of agreement with real-life testing before and it is all down to how we were able to model the different structural elements in COMSOL Multiphysics.”

— FINN LØVHOLT, NGI

from the outside to the inside of buildings is greater. We are interested in what happens at the threshold of hearing,” explains Løvholt. “We want to understand how sounds from external sources interact with buildings and generate vibration that is perceived by people. We can then recommend countermeasures to prevent vibration and may be able to propose standard units that recognize the need to account for the ‘annoyance’ factor.”

⇒ **SIMULATING THE SPREAD OF SOUND WAVES**

Løvholt and his colleagues decided to create a computer model that would allow them to pick apart the mechanism of low-frequency sound waves hitting and penetrating a building. They used the COMSOL Multiphysics® software to simulate a wooden structure with two rooms separated by a wall (see Figure 1, top), closely mimicking the laboratory experiment setup. Within the model, they assigned a loudspeaker to one room, a microphone to the other, and placed various probes around the structure in order to monitor sound pressure levels and vibrations. Every component was carefully modeled,

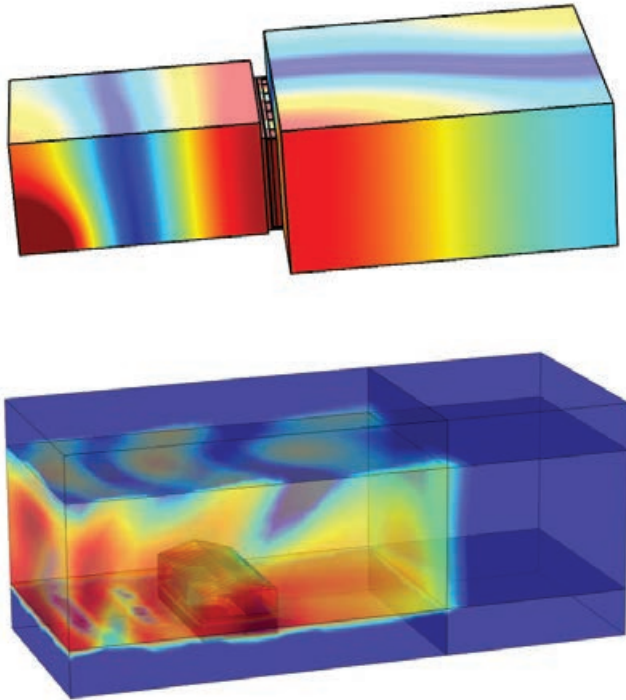

FIGURE 1. Top: Simulated sound pressure in a laboratory with two chambers divided by a wall. A loudspeaker is placed in the room on the left-hand side. The simulations show that the acoustic resonances within each room affect the sound insulation. Bottom: Simulated low-frequency sound originating from outside, around, and inside a building. In both cases, the colors indicate the variation in the sound pressure within the rooms and the wall cavities.

including the steel frame, the air cavity and studs in the wall, the windows, the plywood sheet, and the plasterboard. “Each element has a resonance that depends on the wavelength of the sound wave and the pressure distribution. For example, there is high pressure in the speaker room and lower pressure in the microphone room, and the resonance of a wall will depend on its length, thickness, and stiffness,” explains Løvholt.

The team also had to recognize compound resonances created when two components are joined, such as two pieces of timber that are screwed together. “The advantage of COMSOL

Multiphysics is that it allows us to enter all the parameters we need to monitor. In particular, it enables us to couple physics, so we can, for example, look at the acoustics of open-air sound interacting with indoor structural dynamics. The coupling works both ways so we can identify feedback. This coupling is crucial for our analysis because sound waves can generate a huge range and variety of resonances. The model really allows us to see these.”

The NGI team then validated their simulation with laboratory testing of low-frequency sounds as they were transmitted through a wooden construction with

two rooms. Løvholt explains that the motion of the wall and the sound pressure level are the main quantities measured and results show very close correlation to the COMSOL Multiphysics model (see Figure 2). “The response of the real wall is very clear and the model mimics it almost perfectly. This is the most spectacular aspect.”

The model shows that the transmission of sound within a building is governed by the way in which low-frequency waves interact with the fundamental modes of the building components, the dimensions of the room, and the way in which air leaks from the building envelope. Vibrations in ceilings and walls seem to be the dominant source of low-frequency indoor sound, with floor vibration driven by sound pressure inside the room.

⇒ **CHEAPER AND QUICKER THAN PHYSICAL TESTING**

“We now have a tool to predict sound and vibration at low frequencies,” Løvholt says. “We can use it to design and test mitigation measures such as the lamination of windows and the stiffening of walls — if a wall or window moves less, sound transfers less. In addition, the model shows us the influence small details have on the system; for example, how the screw connection between studs and plasterboards can reduce the effect of a countermeasure, as they actually reduce the overall stiffness of the structure.”

The next stage for the team is full-scale field tests on a real house in an area of Norway that is exposed to aircraft noise. Meanwhile, the team will continue to use and develop the model. “We have never achieved this level of agreement with real-life testing before and it is all down to how we were able to model the different structural elements in COMSOL Multiphysics,” concludes Løvholt. “The model enables us to make decisions and assign countermeasures. This is much cheaper and quicker than physical testing. The model may then be expanded to simulate the sound propagation and vibration in an entire building” (see Figure 1, bottom). ❖

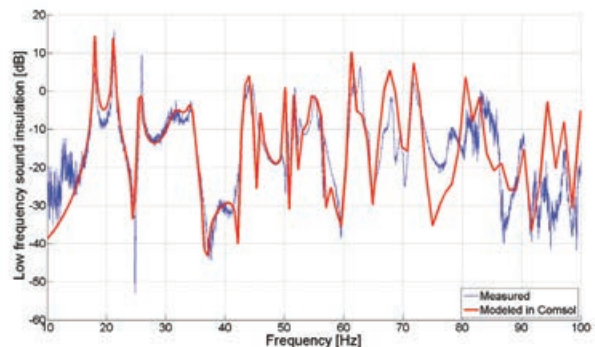

FIGURE 2. The model accurately captures the location of the resonances as well as the level within a few decibels. As the frequency increases, more modes in smaller and smaller structures will get excited. This shows as the increasing difference between the measurements and the model results.

On the Cutting Edge of Hearing Aid Research

Engineers at Knowles bring the hearing aid industry together to fight feedback with multiphysics simulation.

by **GARY DAGASTINE**

In the United States, nearly 20% of the population is reportedly hearing impaired — although that figure could be higher because many people are reluctant to admit they have a hearing problem. Those who are treated rely on miniature and discreet hearing aid devices to improve their hearing, hence their quality of life. Significant R&D effort is required to bring a hearing instrument from a prototype stage to a marketable hearing aid device.

Engineers face daily technical challenges in hearing aid design. Feedback is a major issue that leads to high-pitched squealing or whistling, and limits the amount of gain the aid can provide. “Feedback usually occurs when a hearing aid’s microphone picks up sound or vibration inadvertently diverted from what’s being channeled into the ear canal and sends it back through the amplifier, creating undesirable oscillations,” explains Brenno Varanda, a senior electroacoustic engineer at Knowles Corp. in Itasca, IL.

“For many of Knowles’ customers, designing a new hearing aid is a costly, time-intensive process that could take anywhere from 2 to 6 years to complete,” Varanda explains. Accurate modeling helps designers select speakers, refine vibration isolation mounts, and package components to reduce the amount of speaker energy that is fed back to the microphone. The industry is in dire need of simple transducer models that will expedite that process, and provide more effective options to consumers. Complete models of speakers and microphones are quite complex, and incorporate many factors that are not necessary for

feedback control. “While understanding the electromagnetic, mechanical, and acoustic physics of our transducers is important to transducer designers at Knowles, all of that complexity is not necessarily useful for our customers.” Varanda says.

As a global leader and market supplier of hearing aid transducers, intelligent audio, and specialty acoustic components Knowles took a multilateral initiative to develop transducer vibroacoustic models that are easy to implement and compatible with its hearing health customers. The models are intended to help hearing aid designs graduate from a prototype stage to a final product in a more efficient manner without having to sacrifice accuracy.

⇒ HEARING AID DESIGN AND FEEDBACK

When designing hearing aids two major conflicting requirements must be accounted for by engineers. They must be compact and unobtrusive, yet still capable of providing a powerful sound output to overcome the user’s hearing loss. The user is far more likely to wear a hearing aid if they are discreet and lightweight. This makes solving the feedback issue more challenging. “A common design challenge is to cram all the hardware components into the smallest space possible without causing feedback instability,” Varanda continues.

A typical small behind-the-ear (BTE) hearing aid comprises microphones to convert ambient sounds into electrical signals, a digital signal processor and amplifier to process and boost the electrical signals, and a tiny loudspeaker,

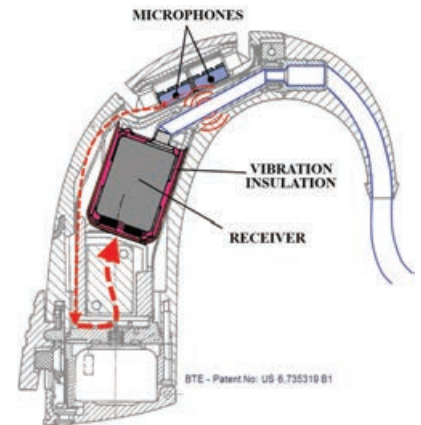

FIGURE 1. A typical BTE hearing aid includes microphones, vibration insulation, and a receiver, among other components. The tight spacing of these components invites troublesome acoustic and mechanical feedback. (Image credit: Knowles Corp.)

also known as a receiver (Figure 1). The receiver, or speaker, “receives” amplified electrical signals and converts them into acoustic energy, or sound, which is then channeled into the ear canal through a tube or an ear mold.

The receiver contains an electromagnetically controlled lever, known as the reed, connected to a diaphragm which generates sound through its oscillating motion. The internal electromechanical forces also generate reaction forces which transmit vibrations through the hearing aid package, creating sound that is picked up by the microphone. This signal in turn is magnified by the amplifier and returned again to the receiver, causing feedback. This path is shown in Figure 1.

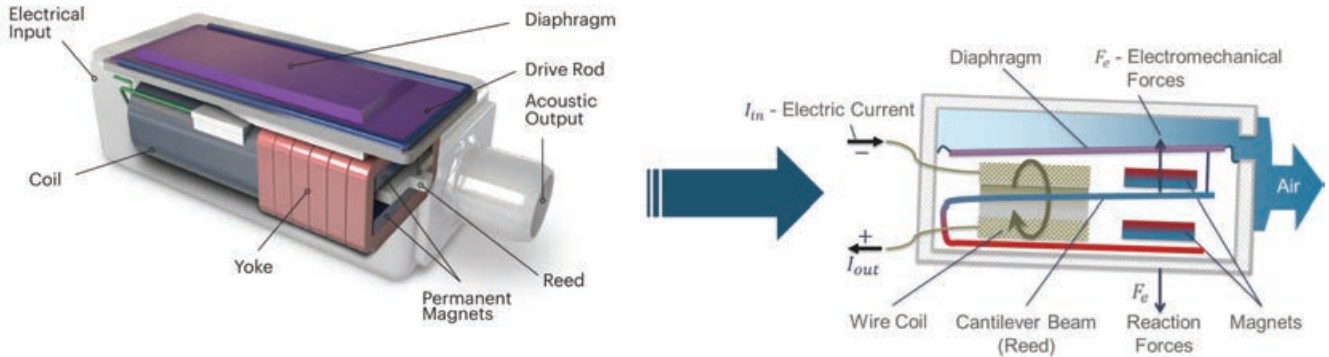

FIGURE 2. A receiver, a key hearing aid component, contains a tiny loudspeaker with an electromagnetically controlled diaphragm that generates sound. Internal electromagnetic forces cause structural vibration that results in mechanical feedback.

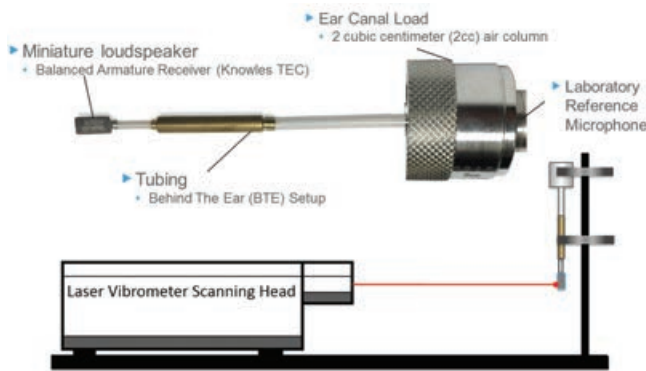

FIGURE 3. Hardware and schematic of the experimental setup.

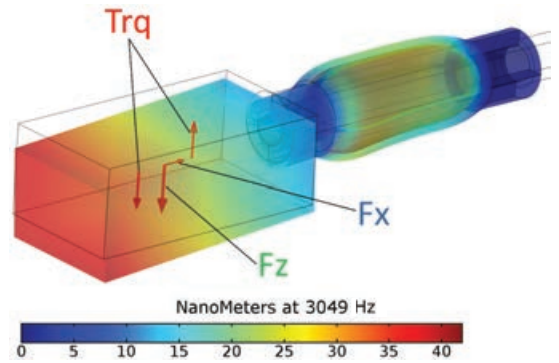

FIGURE 4. Simulation force and displacement results at 3 kHz of the receiver and silicone tube attachment.

⇒ **THE “BLACK BOX” MODEL**

The receiver’s only function is to convert the amplified voltage signal from the microphone into sound. While the construction appears simple, the process is rather complex (Figure 2). The electrical signal is first converted to a magnetic signal, then to a mechanical signal, and finally into an acoustic signal. Each of these steps has its own frequency-dependent characteristics. Understanding the combined effects of all the internal components is vital to the ability of effectively designing receivers for all different hearing aid platforms. Engineers at Knowles have been using complex circuit-equivalents to model all of their internal electrical-magnetic-mechanical-acoustic effects since the 1960s.

Accurately modeling the full complexity of a receiver requires a dauntingly large and complex multiphysics finite element model, making it impractical for fast and efficient hearing aid design. This issue was overcome

when Dr. Daniel Warren, a hearing health industry expert in receiver and microphone research, introduced a ‘black box’ model in 2013. The design uses a minimum amount of simple circuit elements to capture the essential electroacoustic transfer function between voltage and output sound pressure level for balanced armature receivers, while leaving out factors that are unimportant to feedback control.

A key step to simplifying the model was when Warren and Varanda demonstrated that the simplified electroacoustic circuit could be converted into a powerful vibroacoustic model while adding very little complexity to the model. “The conversion is achieved by probing a section of the ‘black box’ circuit where the voltage across inductors is directly proportional to the internal mechanical forces responsible for structural vibration,” Warren explains.

The “black box” and vibroacoustic models needed to be tested and

validated against realistic acoustic and mechanical attachments to the receiver before designers could start using them for product designs. A worldwide collaboration between Knowles and its hearing health customers got started in 2014 to validate the models using the COMSOL Multiphysics® software and industry standard tests.

⇒ **WORKING TOGETHER ON VALIDATION**

To validate the models, engineers needed to measure the acoustic output and vibration forces at the same time, using a structure that could be easily modeled in FEA. Like common hearing aid tests, this test involved connecting a receiver to a short section of tubing leading to an enclosed cavity with a two cubic centimeter (2 cc) volume, which is a standardized ear canal acoustic load as shown in Figure 3. The acoustic pressure inside the cavity is measured with a laboratory-grade microphone. To

help verify the robustness of the model, the receiver was also measured using a complex tubing assembly similar to a BTE hearing instrument. The long tubing in this design varies in diameter, and is long enough to support multiple acoustic resonances. At the same time the acoustic output was being measured, the receiver's structural motion was captured by a laser vibrometer. Both translational and rotational motion were measured by observing the motion at multiple points on the surface of the receiver housing.

Warren and Varanda collaborated with several Knowles customers to perform the measurements described above. With the help of COMSOL Multiphysics, they were able to implement the simplified vibroacoustic circuit model into a simulated replica of the test setup described above. The simulation couples the mechanical interaction between the motion of the receiver and the silicone tubing attachment, thermoviscous losses within the various tubing cross sections,

and acoustic pressure loads inside the cavity and tubing with the internal electro-magnetic-acoustic effects in the "black box" receiver model.

The COMSOL model revealed the dependence of the output pressure and mechanical forces on the applied voltage, frequency, and material properties. Figure 4 shows the displacement results from the simulation at 3 kHz and the reaction forces coupled to the receiver.

When Varanda compared the results of simulations with the physical measurements, they showed excellent agreement (Figure 5). The forces acting on the diaphragm and the reed are acoustically dependent on the output sound pressure. However, the coupling between the forces acting on the diaphragm with the structural reaction forces proves to be, as expected, directly proportional.

⇒ **SPREADING THE KNOWLEDGE**

Knowles shares their model to empower engineers at other hearing aid companies to solve their own system feedback troubles. With a complete representation of the acoustic, mechanical, and electromagnetic behavior inside the hardware, designers are well set up to virtually optimize their products.

"COMSOL is one of the few modeling and simulation tools that can easily couple the lumped 'black box' receiver circuit with acoustics and solid mechanics," says Varanda. "Until now, verifying and optimizing hearing aid designs has been as much art as science.

We will be very happy to see new hearing instruments designs that have benefitted from these models."

By joining forces, the intercompany effort has made it easier for everyone in the hearing health industry. "Ultimately, hearing aid designers don't want to get bogged down with complex transducer models and time-consuming simulations. They simply want focus on their own design and to swap transducers in and out to see how everything will work together," he adds. "This COMSOL model enables them to do this. The behavior of hundreds of transducers can be easily compared for one hearing aid package."

Hearing aid designers now have the capability to reduce feedback and improve overall performance better, faster and more economically than before, which will lead to options for people who are hearing impaired. ❖



Brenno Varanda, senior electroacoustic engineer, Knowles Corp.

“With multiphysics simulation hearing-aid designers now have the capability to reduce feedback and improve overall performance better, faster, and more economically than before, which will lead to better options for people who are hearing impaired.”

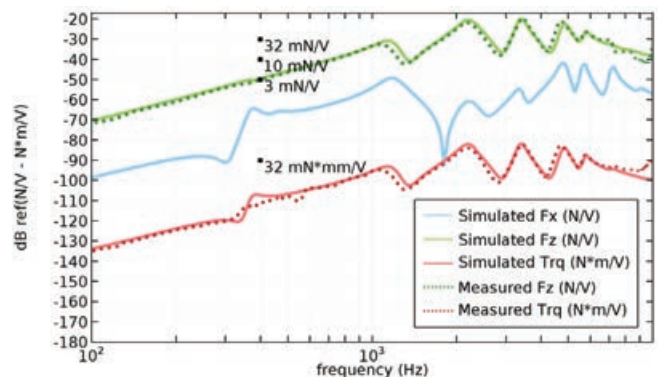
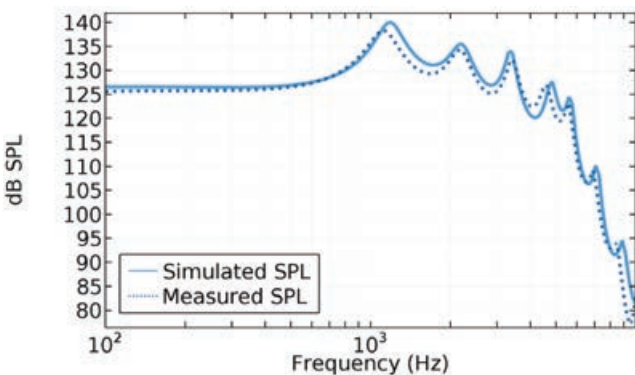

FIGURE 5. Left: Measured (dotted line) vs. simulated (solid line) sound pressure level inside a 2-cc coupler. Right: Measured (dotted line) vs. simulated (solid line) forces and torque acting on the receiver.

MULTIPHYSICS ANALYSIS ADVANCES WATER MAIN LEAK DETECTION

Predicting the speed of sound is important for accurately locating leaks in buried pipes such as water mains. Echologics Engineering has implemented a finite element simulation framework to model acoustic behavior in pipes and estimate variations in the speed of sound.

by VALERIO MARRA

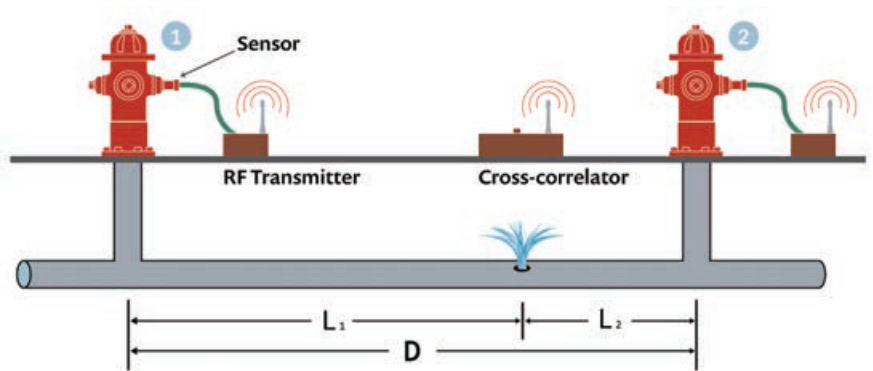

FIGURE 1. Left: Leaky pipe under investigation. Right: Schematic of leak detection setup. A leak is bracketed by two sensors whose distance is D . The leak sound propagates in both directions and a correlator measures the time it takes to reach each sensor. Based on the speed of sound in the pipes, the exact leak location can be found.

Fresh, clean water is a precious commodity that municipalities cannot afford to waste in underground pipe leaks. As pipe infrastructure ages, finding leaks becomes more difficult. As water grows in value, finding leaks becomes more critical.

That is where the Toronto-based company Echologics, a division of Mueller Canada, Ltd., with its unique acoustic technology for noninvasive leak detection, enters the picture. “Leaks make noise,” explained Sebastien Perrier, R&D acoustical scientist at Echologics. Perrier is a mechanical engineer who specializes in acoustics and vibrations, the coupling of structures, as well as signal processing. “The pipes talk and, if you listen, they’ll tell you where leaks are located,” he said.

Echologics measures the time-of-flight of the sound using a correlation function and acoustic sensors set on the pipes or

fire hydrants. If a leak occurs somewhere between two sensors, the leak is detected and the correlation result is used to determine the time difference the leak noise takes to reach each sensor. This provides the distance from the leak to each sensor once the speed of sound is known in the pipes under investigation (Figure 1).

A leading innovator of acoustic systems for water infrastructure, Echologics designs technologies that exploit this correlation to find leaks and to continuously monitor pipes for leaks. Examples of Echologics products include the LeakFinderST™ leak noise correlator (Figure 2) and the EchoShore®-DX pipeline monitoring system (Figure 3). Echologics correlators allow field specialists to investigate leaks in a variety of pipes using transmitters, sensors, and a user interface that can be set up on a standard laptop. This acoustic technology

can detect even very small leaks in the early stages of formation, saving municipalities’ money and pipe damage since they monitor leaks as they grow and are able to take action quickly.

The technology powering Echologics’ products requires a precise understanding of the speed of sound in different types of pipes. It is material dependent, proportional to the stiffness of the pipe, and influenced by the pipe geometry. “The key was developing technology sensitive enough to make leak detection possible in PVC pipes,” explained Perrier. Plastic has high attenuation and dampening compared with metal. Even trickier is the fact that older water systems originally made with cast iron pipes are being repaired — in individual segments — with plastic.

Keeping the sophisticated acoustic correlation algorithms up to date and accurate is one of Perrier’s



FIGURE 2. The LeakFinderST™ correlator is a compact, intuitive leak noise correlator.



have occurred that wasn't included in the test. Perrier's simulation also predicts the pressure in a pipe network as the acoustic wave travels to the sensor, as well as mechanical damping accounting for sections of different materials, offering a way to visualize the problem (Figure 4).

⇒ ROUTINE USE AND SIMULATION APPS

With routine use of the computational model, Perrier saw the advantage in building a custom simulation app. Based on his COMSOL Multiphysics® software analysis and using built-in tools in the software, he created his own app that combines acoustic-structure interaction, pipe acoustics, and time-dependent and frequency studies (Figure 5). The app allows the user to vary geometry and material properties in multiple runs, and analyze a pipe segment or an entire network.

Using the app a user can define a water main network by specifying segment lengths, number of segments, and pipe characteristics. Speed of sound is computed by selecting material properties from a predetermined list, such as cast iron or plastic. The simulation then incorporates the results from field measurements, which a user would manually enter based on correlations to predict leak locations.

Turning the multiphysics model into a simulation app is convenient for



FIGURE 3. The EchoShore®-DX System turns existing fire hydrants into smart leak detection technology.

responsibilities. He must understand the physics involved at a fundamental level in order to optimize and develop next-generation solutions for buried pipe infrastructure. To help him speed up the design process and share his findings with other departments, Perrier creates computational acoustic models and builds simulation apps based on them.

⇒ CATCHING LEAKS BEFORE THEY CAUSE FAILURES

How does numerical simulation help predict acoustic wave propagation in pipes? The pipe network analysis can be complex and time consuming. One may want to understand the sound propagation and vibration response from a single pipe perspective or from an entire network. Therefore, the complexity of the model and the time it takes to run the analysis can change considerably depending on the level of

details needed for the physics involved in the model to be accurate.

Making sure that the sound propagation speed is accurate for each pipe segment is at the heart of the problem that Perrier solved at the early stage of the design process. He then adopted multiphysics simulation to give him faster access to the values relevant to his work. In a pipe networks analysis, multiphysics couplings between acoustics, flow, and structural mechanics are needed.

In Perrier's work, there are multiple uses for simulation. Such as being able to understand slight margins of error and fine-tune the technology. Exploring material and geometry parameters for a pipe network through acoustics simulation reveals predictions for different scenarios. The acoustics simulation exhibits the presence of signal noise when the sensors' distance varies, or indicates that a plastic repair must

“By building simulation apps I can share a complex model with colleagues and make it accessible anywhere.”

— SEBASTIEN PERRIER, R&D ACOUSTICAL SCIENTIST, ECHOLOGICS

interacting with others in the company. “By building simulation apps I can share a complex model with colleagues and make it accessible anywhere,” Perrier said. Simulation apps can be password protected and deployed with a local installation of the COMSOL Server™ product, making it possible to quickly push app updates and maintain confidentiality.

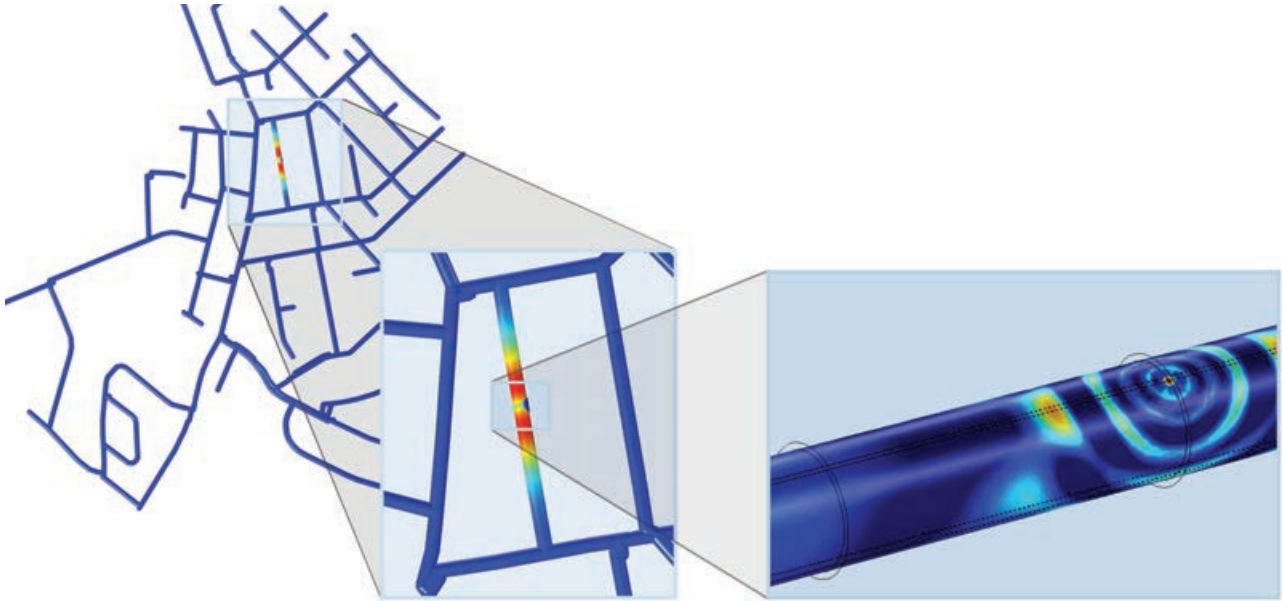

FIGURE 4. Sound propagation analysis of a leak noise in a pipe network. The plot shows the acoustic pressure in the area surrounding the leak.

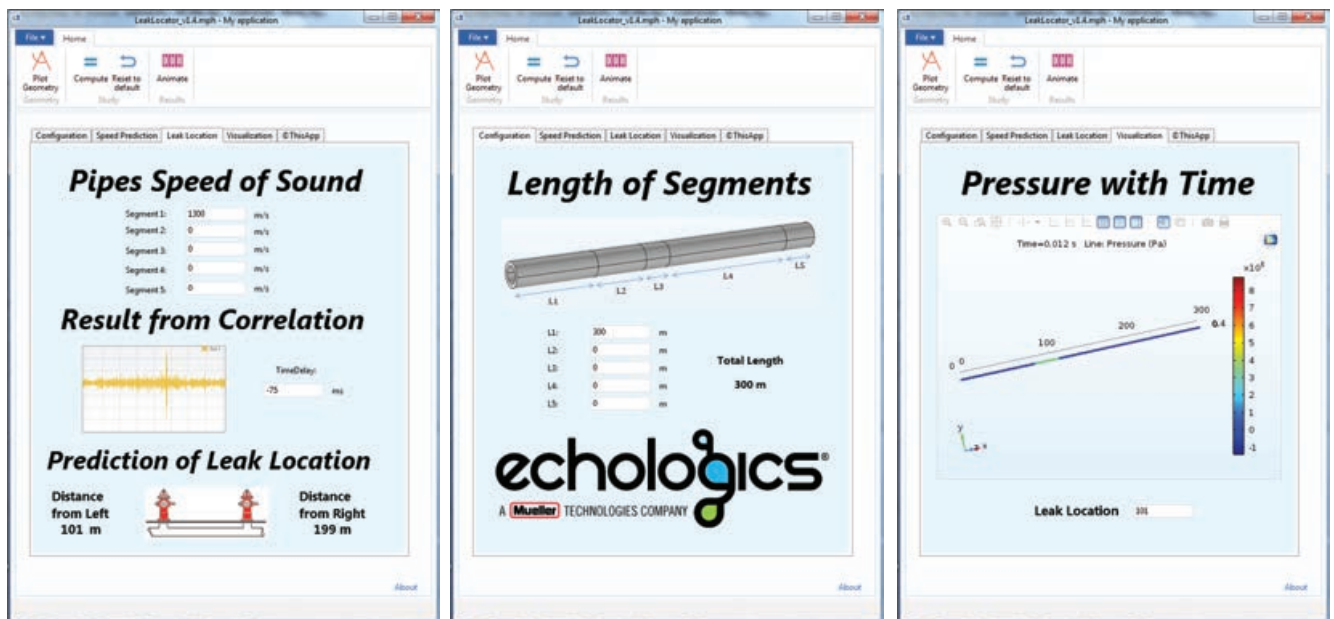

FIGURE 5. An easy-to-use interface guides a user to predict an accurate leak location by defining geometry and pipe characteristics. The app calculates the speed of sound in the pipe and allows the user to visualize, with an animation, the sound propagation from the leak location, while hiding the complex calculations for acoustic-structure interaction and location prediction.

This was a key attribute for him, noting that much of what he does is confidential. He created the app so it could be run by field engineers' on-site.

He expects that the app will be broadly used within Echologics. The key is for Echologics field engineers to be able to quickly and accurately find leaks without

having a detailed understanding of the mechanics or mathematics behind the simulation. A powerful tool, in Perrier's vision, is a simulation that visualizes the propagation of sound and lets users see whether the speed of sound is decreasing or increasing when the geometry or material properties change. ❖



Sebastien Perrier, R&D acoustical scientist at Echologics.

Music to Your Ears: New Transducers Meet Electrostatic Headphones

An audio technology startup delivers new manufacturable transducers for high-end electrostatic headphones and reduces low-end roll-off.



by **JENNIFER HAND**

Serious hi-fi enthusiasts get excited about the musical experience delivered by electrostatic headphones. Producing a natural, airy sound, they provide greater clarity, less distortion, and extended bandwidth when compared to other types of headphones where high resolution audio sources are involved.

Most electrostatic speakers apply an electric charge on a thin elastic membrane situated between two conductive plates. The charged membrane moves in direct response to the electrical input, generating the sound waves that our ears and brain interpret as music, and moving us to joy and tears.

Despite their high quality and accurate audio reproduction, electrostatic speakers can be prohibitively expensive, sometimes fragile, and until recently, were handmade because of mechanical precision requirements. Seeing a need for affordable, high-quality headphones that could be manufactured more easily, Warwick Audio Technologies Limited (WAT) designed the High-Precision Electrostatic Laminate (HPEL) transducer, a patented technology based on an ultrathin diaphragm and a single conductive plate instead of a pair. With its origins at Warwick University in the UK, WAT has developed a lightweight laminate membrane only 0.7 mm thick that is perfectly suited for electrostatic headphones.

The new HPELs are lightweight thin-film structures manufactured through a continuous roll process. “The technology we’ve developed is unique,” explains Martin Roberts, CEO of WAT. “The HPEL

transducer is made up of a metallized polypropylene film, a polymer spacer with hexagonal cells, and a conductive mesh” (Figure 1).

In the typical setup, direct current (DC) bias voltage is applied to the elastic membrane and alternating current (AC) drive signal to the surrounding plates. WAT’s one-sided speaker involves both the DC bias and the AC drive signal applied to the elastic membrane, with a single wire mesh (plate) positioned opposite the membrane as a ground plane.

The fabrication method makes it possible to reproduce the transducers at a significantly lower cost than traditional electrostatic speakers. This means that for the first time, electrostatics may be considered a commercially viable high-res audio option across a wide range of device types and market segments.

⇒ **SIMULATING ACOUSTIC PLAYBACK**

To develop a transducer like this, which can be easily manufactured and inexpensive without compromising sound quality, the WAT team thoroughly investigated the influence

of many design elements before settling on a final version. “We had developed numerous prototypes that clearly performed. The big issue was that we were not entirely sure how varying individual material and design parameters affected the transducer’s performance,” Roberts says.

The dynamics of the HPEL are

dependent on the extremely complex interplay between membrane tension, AC signal level, speaker geometry, elastic and dielectric material properties, thermoacoustic losses, and the added mass effects of the air next to the open side of the membrane. The designers wanted to improve bass performance by reducing low-end roll-off, minimizing distortion, and

maximizing the sound pressure level for a given electrical input. But they discovered that small changes to any component greatly affected the acoustic output.

Although WAT had significant mechanical, electrical, and acoustic expertise, they had no in-house simulation capability to help them understand this interplay. In order to perform a virtual optimization of the

“We went from making multiple prototypes by hand each week to simply dialing up a new one in the software. In addition to settling on a final design we’re very happy with, it is now easy for us to customize our transducers for clients’ custom requirements.”

— **MARTIN ROBERTS, CEO, WAT**



FIGURE 1. Top to bottom: WAT's HPEL transducers; single laminate, assembled, and exploded views of a finished HPEL transducer. All laminates are made in the UK.

HPEL transducer design they enlisted the help of Xi Engineering, a COMSOL Certified Consultant that specializes in computational modeling, design recommendations, and solving noise and vibration problems in machinery and other technology.

Dr. Brett Marmo, technical director of Xi Engineering, oversaw the

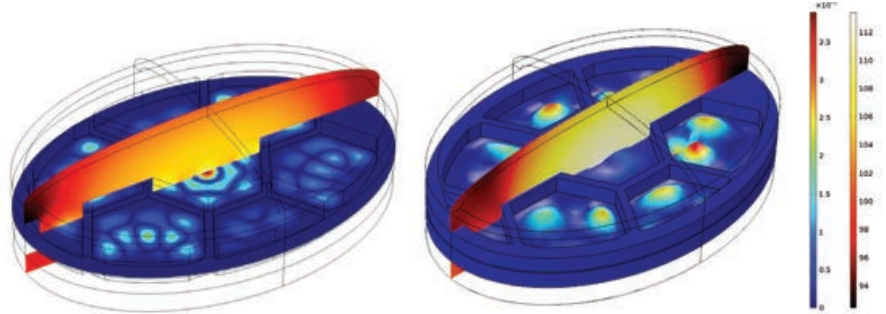

FIGURE 2. Simulation plot showing the sound pressure level (thermal color surface) in dB and the displacement of the membrane (rainbow color surface) in mm from a fully coupled acoustics-MEMS model solved in the frequency domain. Left: solution at 5,000 Hz. Right: solution at 5,250 Hz.

development of the COMSOL Multiphysics® software models they used to analyze the behavior of the HPEL. The software allowed Xi Engineering to model nonlinear effects that would arise with amendments to the HPEL's asymmetrical design.

"We kept the early model simple, focusing on specifics that influence sound quality, for example keeping the first harmonic as low as possible to understand the acoustic-structure interaction and the HPEL's performance at low frequency," Marmo explains, describing their preliminary tests. "Our model showed how applied voltage affects signal levels, which helped us understand sound distortion for an initial case."

Because the transducer is one-sided, the electrostatic force varies with the position of the vibrating membrane, decreasing with the square of the distance between the membrane and the mesh. Once they understood the resulting nonlinear distortion and were able to predict its effects, the WAT engineers could then cancel any related distortions electrically.

⇒ PERFECTING THE HPEL TRANSDUCER DESIGN

In a more extensive simulation that involved a structural-MEMS-acoustic coupling, he examined the impact of adjusting parameters like the size of the hexagonal cells in the wire mesh, thickness of the wires, membrane tension, spacing between membrane and mesh, and material properties of each component. Marmo and his colleagues also studied the effects of different DC

biases, which are often responsible for distortion at low frequencies, and looked at conductivity along the plate to discern whether voltages were higher in one area than another. They then used COMSOL to study the thermoacoustic losses and model the displacement of the membrane for different frequencies (Figure 2).

"We found that this type of simulation was the only accurate way to truly model planar electrostatic transducers," Marmo continues. "For this case, lumped parameter modeling can characterize limited aspects of performance, such as low-frequency amplitude response. One parameter might be excellent but there may be significant distortion created elsewhere. Multiphysics modeling encompasses all dimensions that affect our perception of sound, such as the time-domain response and nonlinear distortion."

The simulations made it possible for the engineers at WAT to tweak design parameters in order to optimize overall performance. Ultimately, they were able to predict what was causing spikes in the frequency response and smooth out the signal for better fidelity.

"This represented a huge cost and time benefit for us," says Roberts. "We went from making multiple prototypes by hand each week to simply dialing up a new one in the software. In addition to settling on a final design we're very happy with, it is now easy for us to customize our transducers for clients' individual requirements."

Marmo's team compared each model with physical measurements provided by the WAT design team. "The simulation

results were astoundingly close to the physical measurements,” comments Dan Anagnos, CTO at WAT. “That was probably the most exciting aspect, seeing the simulation come to life and knowing it was giving us an accurate picture of how the speaker would perform.”

⇒ **FREEDOM AND FLEXIBILITY WITH A SIMULATION APP**

With simulation results verified and validated and WAT satisfied with their design, the next step was for Xi Engineering to put WAT in control of further modeling. The Application Builder available in COMSOL software enabled Marmo’s team to build an app from their simulation and host it online.

The app’s interface allows users to change certain inputs to test changes to a number of parameters, such as the DC bias, AC signal level, frequency range and resolution, material properties, speaker size, wire mesh shape and size, and spacer placement (Figure 3). The original model setup is not accessible from the app; instead, it allows users to run further tests without needing to learn the software.

“Providing WAT with a simulation app removed the need for them to purchase the software or appoint an experienced user,” Marmo says. “Simulation apps put our customers in charge, so they don’t have to come back to us for small changes and they can test exactly what they want. It also frees us to explore new challenges, rather than working on variations of the same problem.” Xi Engineering expects to use computational apps more and more in the course of its work for other customers.

WAT is doing the same, sharing the app with their own customers — companies wanting to find the HPEL transducer best suited to their particular headphone designs. “The team at Xi Engineering have been superb. They have deep expertise and helped to unpack the complexity of our product,” adds Roberts. “The intuitive app that Xi developed for us is an additional bonus. Without revealing any intellectual property we can give our own clients access to our design through the app, so they can test and incorporate the technology into their own high-end headphones.” ❖

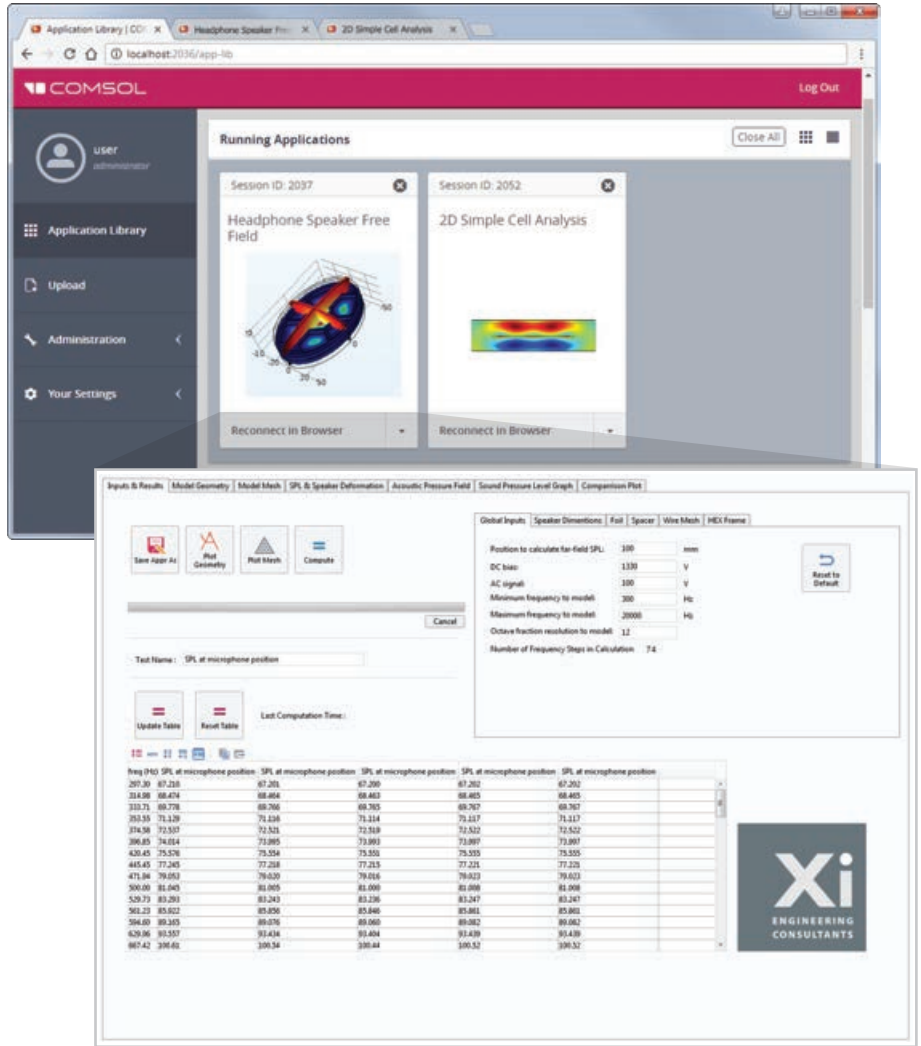

FIGURE 3. Foreground: The app developed by Xi Engineering allows engineers to vary parameters related to frequency, electrical input, speaker dimensions, and properties of the membrane, spacer, and wire mesh. Results give the sound pressure levels for different cases, membrane displacement, frequency response to different DC biases, and a comparison of the simulated design against experimental results. Background: The app is shared through the COMSOL Server™ product and accessible from a web browser or a COMSOL Client for Windows® operating system.



Left: Brett Marmo, technical director at Xi Engineering. Center: Martin Roberts, CEO, Warwick Audio Technology. Right: Dan Anagnos, CTO, Warwick Audio Technology.

Simulating the World Through the Lens of Multiphysics

Real-world applications are inherently multiphysics and should be treated as such.

by **ED FONTES**

What is unique to the COMSOL® software is the way in which the software receives user input and generates a mathematical model, consisting of differential equations, to describe physics phenomena. Any CAE software today is based on predefined numerical models, which are approximations of differential equations. These approximations are necessary as, in most cases, the relevant differential equations cannot be solved analytically, that is — an exact solution cannot be determined. Instead, different types of discretization, such as finite differences, finite volumes, and finite elements methods, among others, are used to approximate the relevant differential equations. It is difficult to add phenomena and descriptions of variables and multiphysics couplings to a numerical model if they are not considered in the differential equations from the beginning. COMSOL differs from other software in that a full mathematical model is generated on the fly, based on the user input, before the discretization is created when the user clicks the Solve button. This core technology allows users to create their own expressions and multiphysics

couplings by using the names of variables and coordinates and by directly typing the mathematical expressions in the user interface. In traditional software, descriptions that are not built-in must be done at the numerical level, and after the discretization has happened, using user-defined subroutines, which may be inaccurate and/or difficult to produce.

COMSOL has an intuitive interface through which the user can input arbitrary mathematical expressions describing material properties, loads, sources, sinks, and multiphysics couplings. This is kind of a paradox, since math is usually perceived as difficult — but our software truly makes it possible to swiftly build extremely complex mathematical models. The mathematical modeling capabilities of COMSOL are transparent, easy-to-use, and highly adaptable to the specific needs of the user.

Researchers and scientists may have a deep understanding and an intuition about a process or phenomena in their field of expertise; in most cases, without being experts in mathematical modeling. It is important that this understanding and intuition is also utilized when

building models and running simulations, since this results in more accurate models and better designs. For this reason, COMSOL provides the Application Builder for creating apps with custom-made user interfaces for specific purposes. The apps allow for both experts and nonexperts in mathematical modeling to validate models and also to benefit from these when optimizing and developing new processes and designs.

One example of this is from Mahindra Two Wheelers (featured on page 15). They use simulations to study the noise and vibration performance of engine, intake, and exhaust systems of motorcycles.

Ulhas Mohite, manager of R&D at Mahindra, informed us that “they created a simulation app using the Application Builder in the COMSOL Multiphysics® software to compare analysis output files and plot the sound pressure level data, which was a great time saver.” In this case, they solved an acoustic problem and simultaneously used the app to compare and analyze simulation data.

Users have been surprising us with their creative designs and uses for apps that we could not have predicted — studying their work and analyzing their feedback have been crucial in the launch of many new software features. All the development that we have made, and will make, to the software aims at facilitating the adoption of accurate numerical simulations at an early stage in order to understand physics phenomena and optimize designs better and faster. The core design of our software reflects our philosophy of studying real-world phenomena through the high-fidelity lens of multiphysics models and simulations. ❖

PRODUCT SUITE

- › COMSOL Multiphysics®
- › COMSOL Server™

ELECTROMAGNETICS

- › AC/DC Module
- › RF Module
- › Wave Optics Module
- › Ray Optics Module
- › Plasma Module
- › Semiconductor Module
- › MEMS Module

STRUCTURAL & ACOUSTICS

- › Structural Mechanics Module
- › Nonlinear Structural Materials Module
- › Geomechanics Module
- › Fatigue Module
- › Multibody Dynamics Module
- › Rotordynamics Module
- › Acoustics Module

FLUID & HEAT

- › CFD Module
- › Mixer Module
- › Subsurface Flow Module
- › Pipe Flow Module
- › Microfluidics Module
- › Molecular Flow Module
- › Heat Transfer Module

CHEMICAL

- › Chemical Reaction Engineering Module
- › Batteries & Fuel Cells Module
- › Electrodeposition Module
- › Corrosion Module
- › Electrochemistry Module

MULTIPURPOSE

- › Optimization Module
- › Material Library
- › Particle Tracing Module

INTERFACING

- › LiveLink™ for MATLAB®
- › LiveLink™ for Excel®
- › CAD Import Module
- › Design Module
- › ECAD Import Module
- › LiveLink™ for SOLIDWORKS®
- › LiveLink™ for Inventor®
- › LiveLink™ for AutoCAD®
- › LiveLink™ for Revit®
- › LiveLink™ for PTC® Creo® Parametric™
- › LiveLink™ for PTC® Pro/ENGINEER®
- › LiveLink™ for Solid Edge®
- › File Import for CATIA® V5

How Computational Acoustics Benefits from Multiphysics

by **NAGI ELABBASI, VERYST ENGINEERING**

The field of acoustics is quite diverse and so is the need for computational tools supporting it. Acoustic simulation is very common in applications like automotive noise control, room acoustics, loudspeakers, miniature speakers, musical instruments, acoustic sensors and actuators, and nondestructive testing. It provides engineers valuable and timely design insights that help optimize their products and evaluate new design concepts. At Veryst Engineering, we find a growing interest in acoustic simulation — especially in applications involving medical devices and MEMS sensors.

The formulations suitable for computational acoustics vary significantly for some of the applications listed above. In many cases, the acoustic problem cannot be solved in isolation from other physics; mainly structural, fluid, electric, heat transfer, and porous media. This multiphysics coupling between acoustics and other phenomena typically becomes more significant the smaller the devices get.

What I currently find exciting about this field is the growing number of acoustic applications I see, especially in two influential areas: medical devices and wearable technology.

We recently worked on a multiphysics acoustic simulation problem within the medical device industry: a lab-on-a-chip device for bodily fluids focusing using acoustophoresis. This method involves the motion of particles resulting from an oscillatory acoustic field and is used for applications including fluid wash, fluid separation, and acoustic levitation. This particular model involves pressure acoustics, solid mechanics,

"What I currently find exciting is the growing number of acoustic applications, especially in two influential areas: medical devices and wearable technology."

electric field, fluid flow, and particle tracing. Geometry and particle properties used in this example model are taken from available literature. The figure shows the particle distribution across the channel, demonstrating effective particle focusing toward the channel center. The computational model helps designers select the dimensions, materials, operating frequency, and flow rate of the device.

Two challenges we often face with acoustic simulations, not too different from other physics, are obtaining accurate material properties and model validation. In my experience, damping is one of the hardest properties to accurately evaluate in acoustic problems. If an acoustic actuator operates close to a resonant frequency, and it frequently does, the effect of damping on the results is significant. If the device also

involves polymeric components, which they frequently do, that damping is most likely frequency dependent. A single damping measure provided by the manufacturer, such as Q factor or loss factor, is simply not enough for an accurate analysis. More material testing and device level testing are frequently needed.

To overcome these challenges and more, we are beginning to develop more simulation apps for clients. Using the Application Builder available in the COMSOL Multiphysics® software, we are able to build applications with an intuitive user interface that is fully customizable based on each client's needs. We hope that these apps will give nonanalysts direct access to the benefits of computational acoustics through a simple user interface. Customers will be able to experiment with parameters or suggest design iterations based on their specific skill set. The field of acoustics has evolved greatly thanks to the power of multiphysics simulation, and we look forward to seeing the expansion of this area through the deployment of simulation apps.

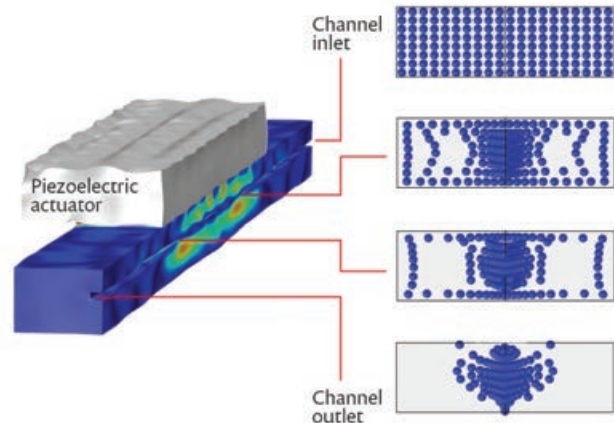

Acoustophoretic particle focusing in a microchannel simulated using the COMSOL Multiphysics® software. Deformation and von Mises stress are also shown.



ABOUT THE AUTHOR

Dr. Nagi Elabbasi is a principal engineer at Veryst Engineering, LLC, and his main area of expertise is modeling multiphysics systems. He has extensive experience in simulating structural mechanics, CFD, heat transfer, acoustics, and coupled systems, and in finite element software development. He holds a PhD in mechanical engineering from the University of Toronto. To learn more about the consulting, testing, and training services offered at Veryst, visit veryst.com/mechanical-engineering-services.